

Medical Cable Products Catalog



Patient Monitoring Interconnect Systems
1-972-771-9434

**DEVICE MANUFACTURERS
CROSS REFERENCE**

TABLE OF CONTENTS

Manufacturer	Section
A D Instruments	F-1
Abbot Medical	F-1
Acuson	F-1
Advanced Technology Labs	F-1
Agilent Technologies	F-1
Air Shields	F-1
American Optical	F-1
Analog Digital Instruments	F-1
ATL and ATL Ultrasound	F-1
BCI	F-1
Becton-Dickinson	F-2
Biochem International	F-2
Burdick	F-2
Circamed	F-2
CMI	F-2
Colin Medical Instruments	F-2
Corometrics	F-2
Criticare Systems, Inc.	F-3
Critikon Inc.	F-3
CSI	F-3
Datamedix	F-3
Datascope	F-3
E for M	F-3
Electrodyne	F-3
GE Medical Systems	F-3
GE TE Medical	F-4
Hewlett-Packard	F-4
Hill-Rom	F-4
Honeywell	F-4
ICR	F-4
Interspec Irex & Irex	F-5
Invivo & Invivo Research	F-5
IVY Biomedical Systems	F-5
J&J	F-5
Laser System & Electric	F-5
Life Science Instruments	F-5
Litton	F-5
LSE	F-5
Mallinckrodt	F-5
Marquette Electronics	F-6
Matrx Medical	F-6
MDE	F-6
Medical Data Electronics (MDE)	F-6
Medical Research Labs	F-6
Medtel	F-6
Medtronic Physio-Control	F-6
Motorola	F-6
MRL (Medical Data Electronics)	F-6
Narco	F-7
Nellcor Inc.	F-7
Nihon Kohden	F-7
North American Draeger	F-7
Novametrics Medical Systems	F-7
Philips Medical Systems	F-7
Physio-Control	F-8
Pioneer	F-8
PPG	F-8
Protocol Systems	F-8
Puritan Bennett	F-8
Quinton Instruments	F-8
Siemens Electromedical Systems	F-8
Spacelabs Medical	F-8
Tektronix	F-9
Temtech	F-9
Viasys	F-9
Viatek	F-9
Vickers	F-9
Welch Allyn Protocol	F-10
ZMI and Zoll Medical (ZMI)	F-10

Patient Cables – Shielded	Section A
Patient Cables – Unshielded	Section B
Safety (DIN) Snap Leads	Section C
Safety (DIN) Pinch/Grabber Leads . .	Section D
Safety (DIN) Adapters	Section E
Additional Capabilities	Section F (and throughout)
Device Cross Reference	Section G
Reference Guide	Inside back cover

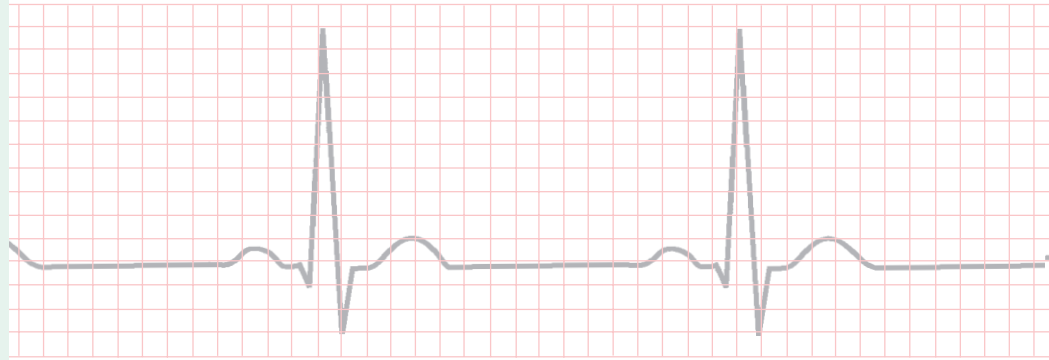

RELIABILITY & SAFETY

- ANSI/AAMI EC 53-1995 Cable and Lead Standards
- IEC 601 Standards
- DIN 42-802 Standards
- FDA Registered Facility (2032351)
- FDA 510K Approved Product Certification (K01809)
- FDA CGMP Manufacturing Practices Followed
- Internal Company Quality Workmanship Standards
- All products are latex-free and surface materials chosen for bio-compatibility.

Patient Cables - Unshielded

AAMI Compliant, Safety (DIN Style) ECG Patient Cables



SAFETY INTERFACE

This series of three and five lead CNA Medical Patient Cables are designed for use with unshielded Safety DIN 42-802 lead wires. *Other configurations are available as custom items.*



DEVICE CONNECTORS

CNA Medical stocks patient cables that are compatible with an extensive list of medical monitoring devices. All device connectors are overmolded with medical grade Santoprene® and feature flexible strain reliefs for durability and ease of use.

Santoprene® is a registered trademark of Advanced Elastomer Systems.

SHIELDING

All CNA Medical Patient Cables are constructed using cable designed to our exacting specifications with medical grade Santoprene® (TPE) jacket, copper center conductors, PE insulation and dual shielding. This low noise cable minimizes triboelectric noise and electrical interference. *Cable yokes can be made with inductors (HF Chokes) or resistors if required. Where monitors are subject to EMI or ESU interference, cables may need to be equipped with ferrite beading. Contact Sales for availability of filtered cables.*

SHEET CLIP

Anchors cable in place while in use.

FLEX RELIEFS

Robust, Santoprene® flex reliefs are located at yoke and device ends of all cables ensuring long life and reducing continuity disruption.

TRACEABILITY

All Patient cables are clearly marked with part numbers and lot control information.

YOKE MARKING

To facilitate lead attachment, cable yokes are labeled to clearly show channel designations and color codes. AHA and IEC color codes are available. *Custom marking is available.*

SANTOPRENE® (TPE) is the latex-free material chosen for use in our cables and leads. Yokes, overmolds and flex reliefs are fabricated using the same TPE used in the wire and cable jackets to provide the most solid bond between cable components. This increases product life and patient comfort and safety. Santoprene® can be sterilized using most common methods: gamma irradiation and EtO. It is impervious to most cleaning solutions and solvents.

Santoprene® is a registered trademark of Advanced Elastomer Systems.

Patient Cables - Unshielded

AAMI Compliant, Safety (DIN Style) ECG Patient Cables

3 Lead

Part #	Description	Connector #	Resistors
1306	Patient Cable, GE Marquette	004	with 1K
1316	Patient Cable, GE Marquette	004	without
1340	Patient Cable, AAMI 6 Pin	001	with 1K
1351	Patient Cable, AAMI 6 Pin	001	without
1385	Patient Cable, Phillips (HP-Agilent)	002	with 1K
1396	Patient Cable, Phillips (17 pin ECG)	003	with 1K

Please see inside back cover for available connectors.

5 Lead

Part #	Description	Connector #	Resistors
1506	Patient Cable, GE Marquette	004	with 1K
1516	Patient Cable, GE Marquette	004	without
1540	Patient Cable, AAMI 6 Pin	001	with 1K
1551	Patient Cable, AAMI 6 Pin	001	without
1585	Patient Cable, Phillips (HP-Agilent)	002	with 1K
1596	Patient Cable, Phillips (17 pin ECG)	003	with 1K

Please see inside back cover for available connectors.

AHA Standard color coding is used on parts listed on this page.
 AHA alternate, IEC Standard and IEC Alternate color coded cables and matching lead set are available. Call for a quotation.

Variations from standard cables are available, including custom colors, lengths and terminations.

Please contact our Sales Department for pricing.



Patient Cables - Shielded

AAMI Compliant, one-piece ECG Patient Cables

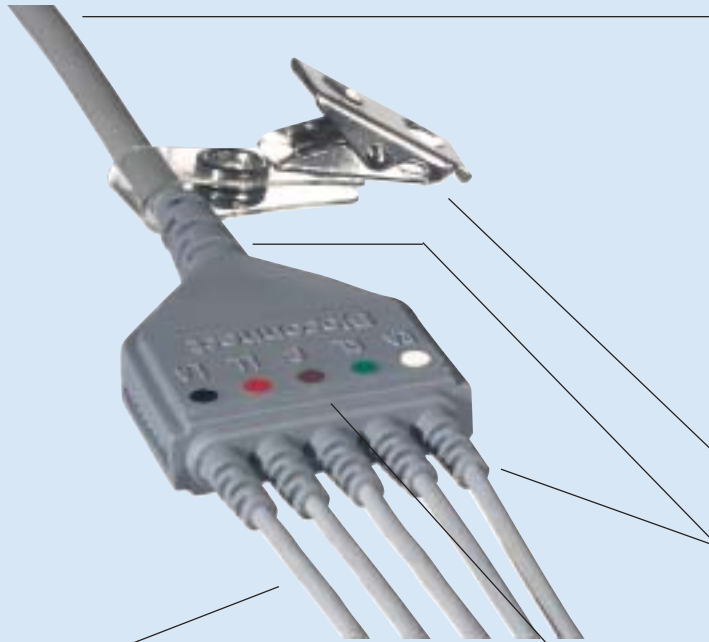

LEAD WIRES

Cable, yoke and lead wires are a single, molded unit which prevents accidental lead disconnection. Unitized cables are optimized for use with defibrillators, in ERs, in ICUs and Mobile Emergency Response Systems. The low profile, compact yoke is available in three and five lead models with snap and pinch lead terminations.



DEVICE CONNECTORS

CNA Medical stocks patient cables that are compatible with an extensive list of medical monitoring devices. All device connectors are overmolded with medical grade Santoprene® and feature flexible strain reliefs for durability and ease of use.

Santoprene® is a registered trademark of Advanced Elastomer Systems.

CABLE SHIELDING

All CNA Medical Patient Cables are constructed using fully shielded trunk cable and lead wires designed to our exacting specifications with medical grade Santoprene® (TPE) jackets, copper center conductors, PE insulation and dual shielding. These low noise cables and wires minimize triboelectric noise and electrical interference. *Cable yokes can be made with inductors (HF Chokes) or resistors if required. Where monitors are subject to EMI or ESU interference, cables may need to be equipped with ferrite beading. Contact Sales for availability of filtered cables.*

SHEET CLIP

Anchors cable in place while in use.

FLEX RELIEFS

Robust, Santoprene® flex reliefs are located at yoke, lead junctions and device ends of all unitized cables ensuring long life and reducing continuity disruption.

TRACEABILITY

All Patient cables are clearly marked with part numbers and lot control information.

YOKE MARKING

To facilitate lead attachment, cable yokes are labeled to clearly show channel designations and color codes. AHA and IEC color codes are available. *Custom marking is available.*

SANTOPRENE® (TPE) is the latex-free material chosen for use in our cables and leads. Yokes, over-molds and flex reliefs are fabricated using the same TPE used in the wire and cable jackets to provide the most solid bond between cable components. This increases product life and patient comfort and safety. Santoprene® can be sterilized using most common methods: gamma irradiation and EtO. It is impervious to most cleaning solutions and solvents.

Santoprene® is a registered trademark of Advanced Elastomer Systems.

Patient Cables - Shielded

AAMI Compliant, one-piece ECG Patient Cables

3 Lead

Part #	Description	Connector #	Resistors
3306	Patient Cable, GE Marquette	004	with 1K
3316	Patient Cable, GE Marquette	004	without
3340	Patient Cable, AAMI 6 Pin	001	with 1K
3351	Patient Cable, AAMI 6 Pin	001	without
3385	Patient Cable, Phillips (HP-Agilent), Fixed	002	with 1K
3396	Patient Cable, Phillips (17 pin ECG), Fixed	003	with 1K

Please see inside back cover for available connectors.

5 Lead

Part #	Description	Connector #	Resistors
3506	Patient Cable, GE Marquette	004	with 1K
3516	Patient Cable, GE Marquette,	004	without
3540	Patient Cable, AAMI 6 Pin	001	with 1K
3551	Patient Cable, AAMI 6 Pin	001	without
3585	Patient Cable, Phillips (HP-Agilent), Fixed	002	with 1K
3596	Patient Cable, Phillips (17 pin ECG), Fixed	003	with 1K

Please see inside back cover for available connectors.

AHA Standard color coding is used on parts listed on this page.
 AHA alternate, IEC Standard and IEC Alternate color coded
 cables and matching lead set are available. Call for a quotation.

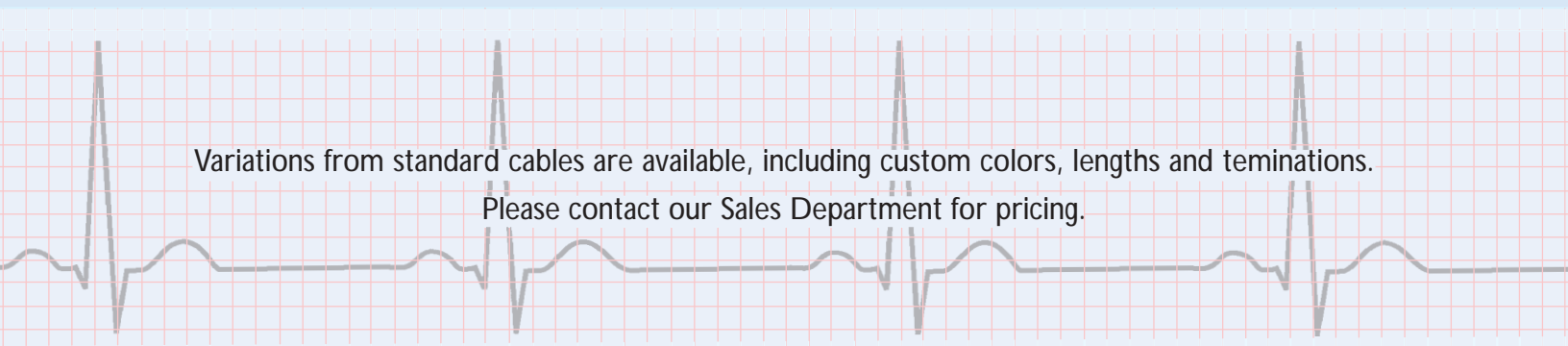

Variations from standard cables are available, including custom colors, lengths and terminations.
 Please contact our Sales Department for pricing.



Safety (DIN) Snap Leads

Meeting ANSI/AAMI EC53 specifications and the requirements of DIN 42-802

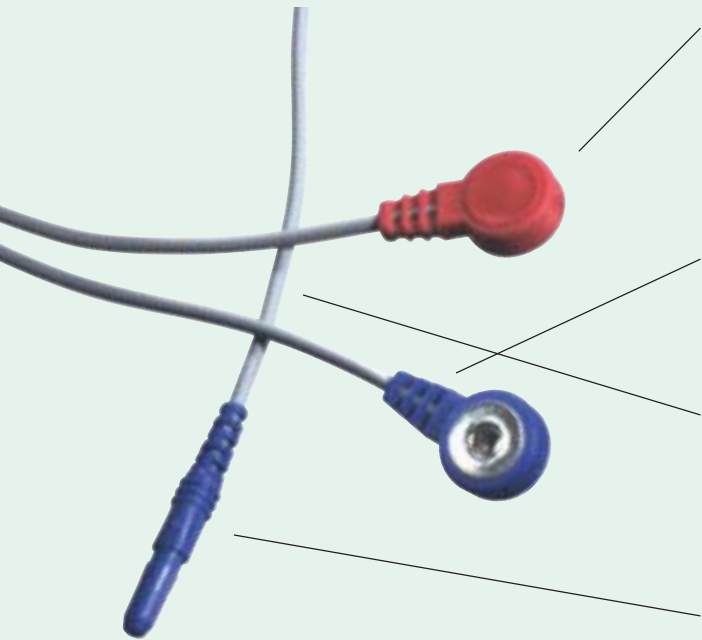

SNAP

Low profile, insert molded Santoprene® (TPE) snap leads offer secure attachment to snap electrodes. Classic teardrop design reduces tangling and increases patient comfort. Color coding per AHA and IEC standards. Snap overmolding can be customized with logo or use indicators in any require color.

STRAIN RELIEF

Molded Santoprene® strain reliefs are designed to extend life expectancy of lead without loss of flexibility and reduce continuity disruption.

LEADWIRE

All unshielded leadwire features 65-strand conductor and Santoprene® jacket for increased flexibility and flex life. By using the same material for molding flex reliefs and in the jacket, the maximum bond is achieved between components.

SOCKET

Recessed lead wire sockets are molded of Santoprene® over a gold plated 1.5mm BeCu spring contact and meet the requirements of DIN 42-802 and ANSI/AAMI EC53 specifications. The design for this socket has been carefully tuned to provide positive retention in any brand of patient cable meeting AAMI specifications.

SANTOPRENE® rubber, which is latex free, is impervious to most cleaning solvents and can be sterilized using most common methods: gamma irradiation, and EtO.

Santoprene® is a registered trademark of Advanced Elastomer Systems.



Variations from standard leads are available, including custom colors, lengths and terminations. Please contact our Sales Department for pricing.

Color Codes

Color coding indicates the part of the body where leads are attached. **AHA/AAMI** (American Hospital Association/Association for the Advancement of Medical Instrumentation) is used in the U.S., while **IEC** (International Electrotechnical Commission) is used in Europe and other parts of the world. "Standard" indicates the primary configuration used. "Alternate" stands for the secondary configuration.

	<u>AHA/AAMI</u>	<u>IEC</u>
Left arm	LA (black)	L (yellow)
Right arm	RA (white)	R (red)
Left leg	LL (red)	F (green)
Right leg	RL (green)	N (black)
Chest	C (brown)	C (white)
Chest position 4	V4 (blue)	
Chest position 5	V5 (orange)	



Safety (DIN) Snap Leads - Sets

Meeting ANSI/AAMI EC53 specifications and the requirements of DIN 42-802

SETS

18" Snap Lead Sets

Sets	Type	1	2	3	4	5	6	7	Part #
3 Lead	Standard AHA	RA	LL	LA					23183-SET
3 Lead	Alternate AHA	RA	RL	LA					23103-SET
3 Lead	Standard IEC	R	F	L					23113-SET
3 Lead	Alternate IEC	R	N	L					23123-SET
5 Lead	Standard AHA	RA	RL	C	LL	LA			23105-SET
5 Lead	Standard IEC	R	N	C	F	L			23115-SET
7 Lead	Standard AHA	RA	LA	LL	RL	C	V5	V4	23107-SET

24" Snap Lead Sets

Sets	Type	1	2	3	4	5	6	7	Part #
3 Lead	Standard AHA	RA	LL	LA					23383-SET
3 Lead	Alternate AHA	RA	RL	LA					23303-SET
3 Lead	Standard IEC	R	F	L					23313-SET
3 Lead	Alternate IEC	R	N	L					23323-SET
5 Lead	Standard AHA	RA	RL	C	LL	LA			23305-SET
5 Lead	Standard IEC	R	N	C	F	L			23315-SET
7 Lead	Standard AHA	RA	LA	LL	RL	C	V5	V4	23307-SET

40" Snap Lead Sets

Sets	Type	1	2	3	4	5	6	7	Part #
3 Lead	Standard AHA	RA	LL	LA					23583-SET
3 Lead	Alternate AHA	RA	RL	LA					23503-SET
3 Lead	Standard IEC	R	F	L					23513-SET
3 Lead	Alternate IEC	R	N	L					23523-SET
5 Lead	Standard AHA	RA	RL	C	LL	LA			23505-SET
5 Lead	Standard IEC	R	N	C	F	L			23515-SET
7 Lead	Standard AHA	RA	LA	LL	RL	C	V5	V4	23507-SET

60" Snap Lead Sets

Sets	Type	1	2	3	4	5	6	7	Part #
3 Lead	Standard AHA	RA	LL	LA					23683-SET
3 Lead	Alternate AHA	RA	RL	LA					23603-SET
3 Lead	Standard IEC	R	F	L					23613-SET
3 Lead	Alternate IEC	R	N	L					23623-SET
5 Lead	Standard AHA	RA	RL	C	LL	LA			23605-SET
5 Lead	Standard IEC	R	N	C	F	L			23615-SET
7 Lead	Standard AHA	RA	LA	LL	RL	C	V5	V4	23607-SET

96" Snap Lead Sets

Sets	Type	1	2	3	4	5	6	7	Part #
3 Lead	Standard AHA	RA	LL	LA					23883-SET
3 Lead	Alternate AHA	RA	RL	LA					23803-SET
3 Lead	Standard IEC	R	F	L					23813-SET
3 Lead	Alternate IEC	R	N	L					23823-SET
5 Lead	Standard AHA	RA	RL	C	LL	LA			23805-SET
5 Lead	Standard IEC	R	N	C	F	L			23815-SET
7 Lead	Standard AHA	RA	LA	LL	RL	C	V5	V4	23807-SET

120" Snap Lead Sets

Sets	Type	1	2	3	4	5	6	7	Part #
3 Lead	Standard AHA	RA	LL	LA					23983-SET
3 Lead	Alternate AHA	RA	RL	LA					23903-SET
3 Lead	Standard IEC	R	F	L					23913-SET
3 Lead	Alternate IEC	R	N	L					23923-SET
5 Lead	Standard AHA	RA	RL	C	LL	LA			23905-SET
5 Lead	Standard IEC	R	N	C	F	L			23915-SET
7 Lead	Standard AHA	RA	LA	LL	RL	C	V5	V4	23907-SET



Safety (DIN) Snap Leads - Packages

Meeting ANSI/AAMI EC53 specifications and the requirements of DIN 42-802

PACKAGES (10 sets per package)

18" Snap Lead Packages (10 sets per package)

Sets	Type	1	2	3	4	5	6	7	Part #
3 Lead	Standard AHA	RA	LL	LA					23183-PKG
3 Lead	Alternate AHA	RA	RL	LA					23103-PKG
3 Lead	Standard IEC	R	F	L					23113-PKG
3 Lead	Alternate IEC	R	N	L					23123-PKG
5 Lead	Standard AHA	RA	RL	C	LL	LA			23105-PKG
7 Lead	Standard AHA	RA	LA	LL	RL	C	V5	V4	23107-PKG

24" Snap Lead Packages (10 sets per package)

Sets	Type	1	2	3	4	5	6	7	Part #
3 Lead	Standard AHA	RA	LL	LA					23383-PKG
3 Lead	Alternate AHA	RA	RL	LA					23303-PKG
3 Lead	Standard IEC	R	F	L					23313-PKG
3 Lead	Alternate IEC	R	N	L					23323-PKG
5 Lead	Standard AHA	RA	RL	C	LL	LA			23305-PKG
7 Lead	Standard AHA	RA	LA	LL	RL	C	V5	V4	23307-PKG

40" Snap Lead Packages (10 sets per package)

Sets	Type	1	2	3	4	5	6	7	Part #
3 Lead	Standard AHA	RA	LL	LA					23583-PKG
3 Lead	Alternate AHA	RA	RL	LA					23503-PKG
3 Lead	Standard IEC	R	F	L					23513-PKG
3 Lead	Alternate IEC	R	N	L					23523-PKG
5 Lead	Standard AHA	RA	RL	C	LL	LA			23505-PKG
7 Lead	Standard AHA	RA	LA	LL	RL	C	V5	V4	23507-PKG

60" Snap Lead Packages (10 sets per package)

Sets	Type	1	2	3	4	5	6	7	Part #
3 Lead	Standard AHA	RA	LL	LA					23683-PKG
3 Lead	Alternate AHA	RA	RL	LA					23603-PKG
3 Lead	Standard IEC	R	F	L					23613-PKG
3 Lead	Alternate IEC	R	N	L					23623-PKG
5 Lead	Standard AHA	RA	RL	C	LL	LA			23605-PKG
7 Lead	Standard AHA	RA	LA	LL	RL	C	V5	V4	23607-PKG

96" Snap Lead Packages (10 sets per package)

Sets	Type	1	2	3	4	5	6	7	Part #
3 Lead	Standard AHA	RA	LL	LA					23883-PKG
3 Lead	Alternate AHA	RA	RL	LA					23803-PKG
3 Lead	Standard IEC	R	F	L					23813-PKG
3 Lead	Alternate IEC	R	N	L					23823-PKG
5 Lead	Standard AHA	RA	RL	C	LL	LA			23805-PKG
7 Lead	Standard AHA	RA	LA	LL	RL	C	V5	V4	23807-PKG

120" Snap Lead Packages (10 sets per package)

Sets	Type	1	2	3	4	5	6	7	Part #
3 Lead	Standard AHA	RA	LL	LA					23983-PKG
3 Lead	Alternate AHA	RA	RL	LA					23903-PKG
3 Lead	Standard IEC	R	F	L					23913-PKG
3 Lead	Alternate IEC	R	N	L					23923-PKG
5 Lead	Standard AHA	RA	RL	C	LL	LA			23905-PKG
7 Lead	Standard AHA	RA	LA	LL	RL	C	V5	V4	23907-PKG

Variations from standard single color leads are available, including custom colors, lengths and terminations. Please contact our Sales Department for pricing.



Safety (DIN) Snap Leads - Packs & Bundles

Meeting ANSI/AAMI EC53 specifications and the requirements of DIN 42-802

PACKS (10 leads per bundle)

Color	18"	24"	40"	60"	96"	120"
Black	23100-PAC	23300-PAC	23500-PAC	23600-PAC	23800-PAC	23900-PAC
Brown	23110-PAC	23310-PAC	23510-PAC	23610-PAC	23810-PAC	23910-PAC
Red	23120-PAC	23320-PAC	23520-PAC	23620-PAC	23820-PAC	23920-PAC
Orange	23130-PAC	23330-PAC	23530-PAC	23630-PAC	23830-PAC	23930-PAC
Yellow	23140-PAC	23340-PAC	23540-PAC	23640-PAC	23840-PAC	23940-PAC
Green	23150-PAC	23350-PAC	23550-PAC	23650-PAC	23850-PAC	23950-PAC
Blue	23160-PAC	23360-PAC	23560-PAC	23660-PAC	23860-PAC	23960-PAC
White	23190-PAC	23390-PAC	23590-PAC	23690-PAC	23890-PAC	23990-PAC

BUNDLES (100 leads per bundle)

Color	18"	24"	40"	60"	96"
Black	23101-BDL	23301-BDL	23501-BDL	23601-BDL	23801-BDL
Brown	23111-BDL	23311-BDL	23511-BDL	23611-BDL	23811-BDL
Red	23121-BDL	23321-BDL	23521-BDL	23621-BDL	23821-BDL
Orange	23131-BDL	23331-BDL	23531-BDL	23631-BDL	23831-BDL
Yellow	23141-BDL	23341-BDL	23541-BDL	23641-BDL	23841-BDL
Green	23151-BDL	23351-BDL	23551-BDL	23651-BDL	23851-BDL
Blue	23161-BDL	23361-BDL	23561-BDL	23661-BDL	23861-BDL
White	23191-BDL	23391-BDL	23591-BDL	23691-BDL	23891-BDL

Color Codes

Color coding indicates the part of the body where leads are attached. **AHA/AAMI** (*American Hospital Association/Association for the Advancement of Medical Instrumentation*) is used in the U.S., while **IEC** (*International Electro-technical Commission*) is used in Europe and other parts of the world. "Standard" indicates the primary configuration used. "Alternate" stands for the secondary configuration.

	AHA/AAMI	IEC
Left arm	LA (black)	L (yellow)
Right arm	RA (white)	R (red)
Left leg	LL (red)	F (green)
Right leg	RL (green)	N (black)
Chest	C (brown)	C (white)
Chest position 4	V4 (blue)	
Chest position 5	V5 (orange)	



Safety DIN Pinch/Grabber Leads

Meeting ANSI/AAMI EC53 specifications and the requirements of DIN 42-802

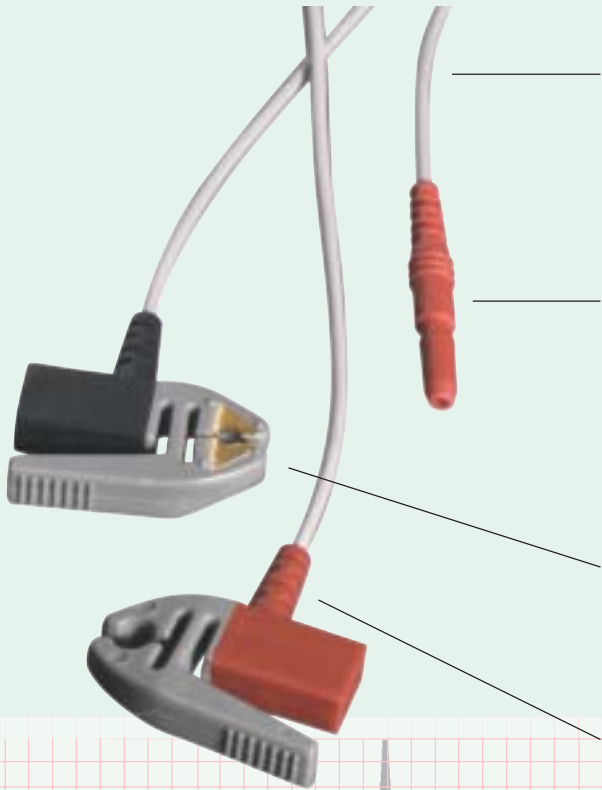

LEADWIRE

Latex-free, urethane insulation is impervious to most cleaning solvents and can be sterilized using most common methods: gamma irradiation and EtO. Conductor is made of Kevlar Tinsel for increased flexibility and minimal discontinuity of signal.

SOCKET

Recessed lead wire sockets are molded of Santoprene® over a gold plated 1.5mm BeCu spring contact and meet the requirements of DIN 42-802 and ANSI/AAMI EC53 specifications. The design for this socket has been carefully tuned to provide positive retention in any brand of patient cable meeting AAMI specifications.

PINCH/GRABBER

The Santoprene® insulated pinch/grabber is made with BeCu spring contacts, both in the pinch mechanism and snap contact points.

STRAIN RELIEFS

Uniquely designed Santoprene® flex reliefs extend life expectancy.

SANTOPRENE® rubber, which is latex free, is impervious to most cleaning solvents and can be sterilized using most common methods: gamma irradiation and EtO.

Santoprene® is a registered trademark of Advanced Elastomer Systems.

Color coding indicates the part of the body where leads are attached. **AHA/AAMI** (*American Hospital Association/Association for the Advancement of Medical Instrumentation*) is used in the U.S., while **IEC** (*International Electrotechnical Commission*) is used in Europe and other parts of the world. "Standard" indicates the primary configuration used. "Alternate" stands for the secondary configuration.

Color Codes

	<u>AHA/AAMI</u>	<u>IEC</u>
Left arm	LA (black)	L (yellow)
Right arm	RA (white)	R (red)
Left leg	LL (red)	F (green)
Right leg	RL (green)	N (black)
Chest	C (brown)	C (white)
Chest position 4	V4 (blue)	
Chest position 5	V5 (orange)	

Safety DIN Pinch/Grabber Leads

Meeting ANSI/AAMI EC53 specifications and the requirements of DIN 42-802

24" PINCH LEAD SETS

Sets	Type	1	2	3	4	5	Part #
3 Lead	Standard AHA	RA	LL	LA			43383-SET
3 Lead	Alternate AHA	RA	RL	LA			43303-SET
5 Lead	Standard AHA	RA	RL	C	LL	LA	43305-SET

24" PINCH LEAD PACKAGES (10 sets per package)

Sets	Type	1	2	3	4	5	Part #
3 Lead	Standard AHA	RA	LL	LA			43383-PKG
3 Lead	Alternate AHA	RA	RL	LA			43303-PKG
5 Lead	Standard AHA	RA	RL	C	LL	LA	43305-PKG

24" PINCH LEAD PACKS (10 of a color per pack)

Color	24"
Black	43300-PAC
Brown	43310-PAC
Red	43320-PAC
Green	43350-PAC
White	43390-PAC

Variations from standard leads are available, including custom colors, lengths and terminations. Please contact our Sales Department for pricing.



Safety (DIN) Lead Adapters – .060

Meeting ANSI/AAMI EC53 specifications and the requirements of DIN 42-802

Safety DIN Leadwire .060 Socket to .060 Socket

SET or SINGLE	18"	24"	40"	Custom Length
Red, White, Black	33103-SET	33303-SET	33503-SET	33X03-SET
Green, White, Black	33183-SET	33383-SET	33583-SET	33X83-SET
Red, White, Black, Brown, Green	33105-SET	33305-SET	33505-SET	33X05-SET
Red, White, Black, Brown, Blue, Orange, Green	33107-SET	33307-SET	33507-SET	33X07
Red	33121	33321	33521	33X21
White	33191	33391	33591	33X91
Black	33101	33301	33501	33X01
Brown	33111	33311	33511	33X11
Blue	33161	33361	33561	33X61
Orange	33131	33331	33531	33X31
Green	33151	33351	33551	33X51

Safety DIN Leadwire .060 Pin to .060 Socket

SET or SINGLE	18"	24"	40"	Custom Length
Red, White, Black	3A103-SET	3A303-SET	3A503-SET	3AX03-SET
Green, White, Black	3A183-SET	3A383-SET	3A583-SET	3AX83-SET
Red, White, Black, Brown, Green	3A105-SET	3A305-SET	3A505-SET	3AX05-SET
Red, White, Black, Brown, Blue, Orange, Green	3A107-SET	3A307-SET	3A507-SET	3AX07-SET
Red	3A121	3A321	3A521	3AX21
White	3A191	3A391	3A591	3AX91
Black	3A101	3A301	3A501	3AX01
Brown	3A111	3A311	3A511	3AX11
Blue	3A161	3A361	3A561	3AX61
Orange	3A131	3A331	3A531	3AX31
Green	3A151	3A351	3A551	3AX51

Variations from standard cables are available, including custom colors, lengths and terminations.

Please contact our Sales Department for pricing.



Safety (DIN) Lead Adapters – .060

Meeting ANSI/AAMI EC53 specifications and the requirements of DIN 42-802

Safety DIN Leadwire .060 Pin to .060 Pin

SET or SINGLE	18"	24"	40"	Custom Length
Red, White, Black	AA103-SET	AA303-SET	AA503-SET	AAX03-SET
Green, White, Black	AA183-SET	AA383-SET	AA583-SET	AAX83-SET
Red, White, Black, Brown, Green	AA105-SET	AA305-SET	AA505-SET	AAX05-SET
Red, White, Black, Brown, Blue, Orange, Green	AA107-SET	AA307-SET	AA507-SET	AAX07-SET
Red	AA121	AA321	AA521	AAX21
White	AA191	AA391	AA591	AAX91
Black	AA101	AA301	AA501	AAX01
Brown	AA111	AA311	AA511	AAX11
Blue	AA161	AA361	AA561	AAX61
Orange	AA131	AA331	AA531	AAX31
Green	AA151	AA351	AA551	AAX51

Safety DIN Leadwire .060 Pin to Snap

SET or SINGLE	18"	24"	40"	Custom Length
Red, White, Black	2A103-SET	2A303-SET	2A503-SET	2AX03-SET
Green, White, Black	2A183-SET	2A383-SET	2A583-SET	2AX83-SET
Red, White, Black, Brown, Green	2A105-SET	2A305-SET	2A505-SET	2AX05-SET
Red, White, Black, Brown, Blue, Orange, Green	2A107-SET	2A307-SET	2A507-SET	2AX07-SET
Red	2A121	2A321	2A521	2AX21
White	2A191	2A391	2A591	2AX91
Black	2A101	2A301	2A501	2AX01
Brown	2A111	2A311	2A511	2AX11
Blue	2A161	2A361	2A561	2AX61
Orange	2A131	2A331	2A531	2AX31
Green	2A151	2A351	2A551	2AX51

Variations from standard cables are available, including custom colors, lengths and terminations.

Please contact our Sales Department for pricing.



Safety (DIN) Lead Adapters – .080

Meeting ANSI/AAMI EC53 specifications and the requirements of DIN 42-802

Safety DIN Leadwire .080 Socket to Snap

SET or SINGLE	18"	24"	40"	Custom Length
Red, White, Black	20103-SET	20303-SET	20503-SET	20X03-SET
Green, White, Black	20183-SET	20383-SET	20583-SET	20X83-SET
Red, White, Black, Brown, Green	20105-SET	20305-SET	2A505-SET	20X05-SET
Red, White, Black, Brown, Blue, Orange, Green	20107-SET	20307-SET	2A507-SET	20X07-SET
Red	20121	20321	20521	20X21
White	20191	20391	20591	20X91
Black	20101	20301	20501	20X01
Brown	20111	20311	20511	20X11
Blue	20161	20361	20561	20X61
Orange	20131	20331	20531	20X31
Green	20151	20351	20551	20X51

Safety DIN Leadwire .080 Pin to Snap

SET or SINGLE	18"	24"	40"	Custom Length
Red, White, Black	21103-SET	21303-SET	21503-SET	21X03-SET
Green, White, Black	21183-SET	21383-SET	21583-SET	21X83-SET
Red, White, Black, Brown, Green	21105-SET	21305-SET	21505-SET	21X05-SET
Red, White, Black, Brown, Blue, Orange, Green	21107-SET	21307-SET	21507-SET	21X07-SET
Red	21121	21321	21521	21X21
White	21191	21391	21591	21X91
Black	21101	21301	21501	21X01
Brown	21111	21311	21511	21X11
Blue	21161	21361	21561	21X61
Orange	21131	21331	21531	21X31
Green	21151	21351	21551	21X51

Variations from standard cables are available, including custom colors, lengths and terminations.

Please contact our Sales Department for pricing.



Safety (DIN) Lead Adapters – .080

Meeting ANSI/AAMI EC53 specifications and the requirements of DIN 42-802

Safety DIN Leadwire .080 Pin to .080 Pin

SET or SINGLE	18"	24"	40"	Custom Length
Red, White, Black	11103-SET	11303-SET	11503-SET	11X03-SET
Green, White, Black	11183-SET	11383-SET	11583-SET	11X83-SET
Red, White, Black, Brown, Green	11105-SET	11305-SET	11505-SET	11X05-SET
Red, White, Black, Brown, Blue, Orange, Green	11107-SET	11307-SET	11507-SET	11X07-SET
Red	11121	11321	11521	11X21
White	11191	11391	11591	11X91
Black	11101	11301	11501	11X01
Brown	11111	11311	11511	11X11
Blue	11161	11361	11561	11X61
Orange	11141	11341	11541	11X41
Green	11151	11351	11551	11X51

Safety DIN Leadwire .080 Pin to .080 Socket

SET or SINGLE	18"	24"	40"	Custom Length
Red, White, Black	10103-SET	10303-SET	10503-SET	10X03-SET
Green, White, Black	10183-SET	10383-SET	10583-SET	10X83-SET
Red, White, Black, Brown, Green	10105-SET	10305-SET	10505-SET	10X05-SET
Red, White, Black, Brown, Blue, Orange, Green	10107-SET	10307-SET	10507-SET	10X07-SET
Red	10121	10321	10521	10X21
White	10191	10391	10591	10X91
Black	10101	10301	10501	10X01
Brown	10111	10311	10511	10X11
Blue	10161	10361	10561	10X61
Orange	10141	10341	10541	10X41
Green	10151	10351	10551	10X51

Variations from standard cables are available, including custom colors, lengths and terminations.

Please contact our Sales Department for pricing.



Medical Device Cross Reference

Connector* 3-Lead 5-Lead
3-Lead 5-Lead
Shielded Shielded

*See Reference Guide inside back cover.

A D INSTRUMENTS

Mac Lab (ECG).....	001	1340	1540	3340	3540
AAEM.....	001	1340	1540	3340	3540

ABBOT MEDICAL

AAXM.....	001	1340	1540	3340	3540
ABBV.....	001	1340	1540	3340	3540
ABBY Series.....	001	1340	1540	3340	3540
ABEM.....	001	1340	1540	3340	3540
ABTM.....	001	1340	1540	3340	3540
ARTM.....	001	1340	1540	3340	3540
DHS.....	001	1340	1540	3340	3540
EK-1.....	001	1340	1540	3340	3540
EK-2.....	001	1340	1540	3340	3540
EK-4.....	001	1340	1540	3340	3540
EK40.....	001	1340	1540	3340	3540
EK-40.....	001	1340	1540	3340	3540
EK-5.....	001	1340	1540	3340	3540
EK50.....	001	1340	1540	3340	3540
EK-50.....	001	1340	1540	3340	3540
EKP-1.....	001	1340	1540	3340	3540
EKR50.....	001	1340	1540	3340	3540
EO-8.....	001	1340	1540	3340	3540
EX-50.....	001	1351	1551	3351	3551
EX50.....	001	1340	1540	3340	3540
Lifecare 5100.....	001	1351	1551	3351	3551
Lifecare 5200.....	001	1351	1551	3351	3551

ACUSON

128XP/10C (Ultrasound)	001	1340	1540	3340	3540
128XP/3 (Ultrasound)	001	1340	1540	3340	3540
Aspen.....	001	1340	1540	3340	3540
Sequoia.....	001	1340	1540	3340	3540

ADVANCED TECHNOLOGY LABS

400.....	001	1340	1540	3340	3540
Ultramark 4 (PLUS).....	001	1340	1540	3340	3540
Ultramark 7.....	001	1340	1540	3340	3540
Ultramark 9.....	001	1340	1540	3340	3540

AGILENT TECHNOLOGIES

12 Pin Connector.....	002	1385	1585	3385	3585
43100A (12-Pin).....	002	1385	1585	3385	3585
43110A (12-Pin).....	002	1385	1585	3385	3585
43120A (12-Pin).....	002	1385	1585	3385	3585
78352C.....	002	1385	1585	3385	3585
78354C.....	002	1385	1585	3385	3585
78834A (Neonatal Bedside).....	002	1385	1585	3385	3585
78834C Neonatal.....	002	1385	1585	3385	3585
Agilent A1.....	001	1340	1540	3340	3540
Codemaster.....	002	1385	1585	3385	3585
Compact M3923A.....	001	1340		3340	
Compact M3925A.....	001	1340		3340	
Compact M3929A.....	001	1340		3340	
M1001A.....	002	1385	1585	3385	3585
M1002A.....	002	1385	1585	3385	3585
M1106A.....	002	1385	1585	3385	3585
M1175A.....	002	1385	1585	3385	3585
M1176A.....	002	1385	1585	3385	3585
M1280A.....	002	1385	1585	3385	3585
M1722A.....	002	1385	1585	3385	3585
M1722B.....	002	1385	1585	3385	3585
M1723A (12-Pin).....	002	1385	1585	3385	3585
M1723B (12-Pin).....	002	1385	1585	3385	3585

Connector* 3-Lead 5-Lead
3-Lead 5-Lead
Shielded Shielded

*See Reference Guide inside back cover.

Merlin System.....	002	1385	1585	3385	3585
OmniCare (CMS).....	002	1385	1585	3385	3585
V24.....	002	1385	1585	3385	3585
V26.....	002	1385	1585	3385	3585
Viridia 24.....	002	1385	1585	3385	3585
Viridia 24 C.....	002	1385	1585	3385	3585
Viridia 24 CT.....	002	1385	1585	3385	3585
Viridia M3.....	002	1385	1585	3385	3585
Viridia M4.....	002	1385	1585	3385	3585

AIR SHIELDS

HRRM 71-1/2.....	001	1340	1540	3340	3540
HRRM-71.....	001	1340	1540	3340	3540
HRRM-72.....	001	1340	1540	3340	3540
Porta-Fib I.....	001	1340	1540	3340	3540
Porta-Fib II.....	001	1340	1540	3340	3540
Porta-Fib III.....	001	1340	1540	3340	3540
System 5 (new).....	001	1340	1540	3340	3540
System 6 (Neonatal).....	001	1340	1540	3340	3540

AMERICAN OPTICAL

1125.....	001	1340		3340	
1700.....	001	1340		3340	
26125.....	001	1340		3340	
33167.....	001	1340		3340	
5260.....	001	1340		3340	
5330.....	001	1340		3340	
Pulsar 4.....	001	1340		3340	

ANALOG DIGITAL INSTRUMENTS

3 Lead ECG Cable.....	001	1351	1551	3351	3551
-----------------------	-----	------	------	------	------

ATL

400.....	001	1340	1540	3340	3540
Ultramark 4 (Plus).....	001	1340	1540	3340	3540
Ultramark 7.....	001	1340	1540	3340	3540
Ultramark 9.....	001	1340	1540	3340	3540

ATL ULTRASOUND

800.....	001	1340	1540	3340	3540
800Plus.....	001	1340	1540	3340	3540
Apogee.....	001	1340	1540	3340	3540
CX.....	001	1340	1540	3340	3540
CX200/400.....	001	1340	1540	3340	3540
HDI 3000.....	001	1340	1540	3340	3540
HDI 9/2000.....	001	1340	1540	3340	3540
Interspec Cardiology XL.....	001	1340	1540	3340	3540
Mark IV.....	001	1340	1540	3340	3540
Mark VII.....	001	1340	1540	3340	3540
Ultramark 4.....	001	1340	1540	3340	3540
Ultramark 4 (Plus).....	001	1340	1540	3340	3540
Ultramark 5.....	001	1340	1540	3340	3540
Ultramark 7.....	001	1340	1540	3340	3540
Ultramark 9.....	001	1340	1540	3340	3540
Ultramark IX.....	001	1340	1540	3340	3540

BCI

3101.....	001	1340	1540	3340	3540
6100.....	001	1340	1540	3340	3540
6200.....	001	1340	1540	3340	3540
9100.....	001	1340	1540	3340	3540
2005.....	001	1340	1540	3340	3540
Advisor.....	001	1340	1540	3340	3540
Life Span 100.....	001	1340	1540	3340	3540



Medical Device Cross Reference

3-Lead 5-Lead
Connector* 3-Lead 5-Lead Shielded Shielded

**See Reference Guide inside back cover.*

BECTON-DICKINSON

Guardian	001	1340	...	1540	3340	3540
Guardian 1001	001	1340	...	1540	3340	3540
MD3A	001	1540	3540
N1001	001	1340	...	1540	3340	3540

BIOCHEM INTERNATIONAL

3101	001	1340	...	1540	3340	3540
6100	001	1340	...	1540	3340	3540
6200	001	1340	...	1540	3340	3540
9100	001	1340	...	1540	3340	3540
(2005)	001	1340	...	1540	3340	3540
Advisor	001	1340	...	1540	3340	3540
Life Span 100	001	1340	...	1540	3340	3540

BURDICK

208 (w/ lead select)	001	1340	...	1540	3340	3540
400 Series (5 lead)	001	1540	3540
4014	001	1340	...	1540	3340	3540
4045 Defib	001	1340	...	1540	3340	3540
408 (w/ lead select)	001	1340	...	1540	3340	3540
412 (w/ lead select)	001	1340	...	1540	3340	3540
413 (w/ lead select)	001	1340	...	1540	3340	3540
414 (w/ lead select)	001	1340	...	1540	3340	3540
500 Series	001	1340	...	1540	3340	3540
511	001	1340	...	1540	3340	3540
512	001	1340	...	1540	3340	3540
514	001	1340	...	1540	3340	3540
521	001	1340	...	1540	3340	3540
522	001	1340	...	1540	3340	3540
524	001	1340	...	1540	3340	3540
526	001	1340	...	1540	3340	3540
600 Series	001	1340	...	1540	3340	3540
701S	001	1340	3340
702S	001	1340	3340
703S	001	1340	3340
900 Series - With Resistor ..	001	1540	3540
900 Series - Without Resistor	001	1551	3551
900 Series (w/ respiration) ..	001	1351	...	1551	3351	3551
900 Series (w/o respiration)	001	1340	...	1540	3340	3540
90300	001	1540	3540
90303B	001	1540	3540
90305	001	1540	3540
90308	001	1340	...	1540	3340	3540
90308-11	001	1340	...	1540	3340	3540
90367 Ultraview	003	1396	...	1596	3396	3596
90369	003	1396	...	1596	3396	3596
90408	001	1540	3540
90418	001	1540	3540
90425	001	1540	3540
90428	001	1540	3540
90431	001	1340	...	1540	3340	3540
90432	001	1540	3540
90470	001	1540	3540
90496	003	1396	...	1596	3396	3596
90600 Series	001	1340	...	1540	3340	3540
90600A Series	001	1340	...	1540	3340	3540
90700	001	1340	...	1540	3340	3540
90700 Series	001	1340	3340
90701	001	1340	...	1540	3340	3540
90721	001	1340	...	1540	3340	3540
90724	001	1340	...	1540	3340	3540

3-Lead 5-Lead
Connector* 3-Lead 5-Lead Shielded Shielded

**See Reference Guide inside back cover.*

Medic 3	001	1340	...	1540	3340	3540
Medic 4	001	1340	...	1540	3340	3540
Medic 4 (Defib)	001	1340	...	1540	3340	3540
Medic 5	001	1340	...	1540	3340	3540
PC Bedside	001	1340	3340
PC Bed Side Series	001	1340	3340
PC Express	001	1340	3340
PCMS System	001	1340	...	1540	3340	3540
PCMS System 90300 Series	001	1340	3340
TEK-208	001	1340	3340
TEK-408	001	1340	3340
TEK-412	001	1340	3340
TEK-413	001	1340	3340
TEK-413 with Lead Select ...	001	1340	...	1540	3340	3540
TEK-413/414 (w/ lead select)	001	1340	...	1540	3340	3540
TEK-414	001	1340	3340
TEK-414 with Lead Select ...	001	1340	...	1540	3340	3540
TEK-511	001	1340	...	1540	3340	3540
TEK-512	001	1340	...	1540	3340	3540
TEK-514	001	1340	...	1540	3340	3540
TEK-521	001	1340	...	1540	3340	3540

CIRCAMED

ECG	001	1351	...	1551	3351	3551
-----------	-----	-------	------	-----	------	-------	------	-------	------

CMI

BP308	001	1340	...	1540	3340	3540
BP308E	001	1340	3340
BP408	001	1340	...	1540	3340	3540
CBM3000	001	1340	...	1540	3340	3540
CMB-3000	001	1340	...	1540	3340	3540

COLIN MEDICAL INSTRUMENTS

BP308	001	1340	...	1540	3340	3540
BP308E	001	1340	3340
BP408	001	1340	...	1540	3340	3540
CBM3000	001	1340	...	1540	3340	3540
CMB-3000	001	1340	...	1540	3340	3540

COROMETRICS

1200 Defib Series	001	1340	...	1540	3340	3540
1500 Defib Series	001	1340	...	1540	3340	3540
8720	001	1340	...	1540	3340	3540
900 Defib Series	001	1340	...	1540	3340	3540
Cinamap 8700	001	1340	...	1540	3340	3540
Cinamap 8710	001	1340	...	1540	3340	3540
Cinamap 8720	001	1340	...	1540	3340	3540
Cinamap 9700	001	1340	...	1540	3340	3540
Cinamap 9710	001	1340	...	1540	3340	3540
Corometrics 556	001	1340	...	1540	3340	3540
Dash 1000	004	1306	...	1506	3306	3506
Dash 2000	004	1306	...	1506	3306	3506
Dash 3000	004	1306	...	1506	3306	3506
Dash 4000	004	1306	...	1506	3306	3506
Eagle Systems	004	1306	...	1506	3306	3506
R-Wave Detector (Starcam)	001	1340	...	1540	3340	3540
Solar 3000	004	1306	...	1506	3306	3506
Solar 8000	004	1306	...	1506	3306	3506
Solar 9500	004	1306	...	1506	3306	3506
Tram 100	004	1306	...	1506	3306	3506
Tram 200	004	1306	...	1506	3306	3506
Tram 300	004	1306	...	1506	3306	3506
Tram 400	004	1306	...	1506	3306	3506

(COROMETRICS continued on next page)



Medical Device Cross Reference - continued

3-Lead 5-Lead
Connector* 3-Lead 5-Lead Shielded Shielded

*See Reference Guide inside back cover.

(COROMETRICS continued from previous page)

Tram 500	004	1306	1506	3306	3506
Tram 600	004	1306	1506	3306	3506
Tram 800	004	1306	1506	3306	3506
Tramscope 12	004	1306	1506	3306	3506
Tramscope 12C	004	1306	1506	3306	3506
Unity Systems	004	1306	1506	3306	3506

CRITICARE SYSTEMS, INC.

1100	001	1340	1540	3340	3540
1508	001	1340	1540	3340	3540
504	001	1340	1540	3340	3540
504US	001	1340	1540	3340	3540
506	001	1340	1540	3340	3540
507	001	1340	1540	3340	3540
508	001	1340	1540	3340	3540
602-4 USP	001	1340	1540	3340	3540
602-A USP	001	1340	1540	3340	3540
Poet 2	001	1340	1540	3340	3540
Scholar	001	1340	1540	3340	3540

CRITIKON INC.

1200 Defib Series	001	1340	1540	3340	3540
1500 Defib Series	001	1340	1540	3340	3540
8720	001	1340	1540	3340	3540
900 Defib Series	001	1340	1540	3340	3540
9720	001	1340	1540	3340	3540
Cinamap 8700	001	1340	1540	3340	3540
Cinamap 8710	001	1340	1540	3340	3540
Cinamap 8720	001	1340	1540	3340	3540
Cinamap 9700	001	1340	1540	3340	3540
Cinamap 9710	001	1340	1540	3340	3540
Cinamap 9720	001	1340	1540	3340	3540
Critikon 8100T	001	1340	1540	3340	3540
Corometrics 556	001	1340	1540	3340	3540
Dash 1000	004	1306	1506	3306	3506
Dash 2000	004	1306	1506	3306	3506
Dash 3000	004	1306	1506	3306	3506
Dash 4000	004	1306	1506	3306	3506
Dinamap	001	1340	1540	3340	3540
Dinamap Plus	001	1340	1540	3340	3540
Dynamap Pro	001	1340	1540	3340	3540
Eagle Systems	004	1306	1506	3306	3506
MPS	001	1340	1540	3340	3540
R-Wave Detector (Starcam)	001	1340	1540	3340	3540
Solar 3000	004	1306	1506	3306	3506
Solar 8000	004	1306	1506	3306	3506
Solar 9500	004	1306	1506	3306	3506
Tram 100	004	1306	1506	3306	3506
Tram 200	004	1306	1506	3306	3506
Tram 300	004	1306	1506	3306	3506
Tram 400	004	1306	1506	3306	3506
Tram 500	004	1306	1506	3306	3506
Tram 600	004	1306	1506	3306	3506
Tram 800	004	1306	1506	3306	3506
Tramscope 12	004	1306	1506	3306	3506
Tramscope 12C	004	1306	1506	3306	3506
Unity Systems	004	1306	1506	3306	3506

CSI

1100	001	1340	1540	3340	3540
1508	001	1340	1540	3340	3540
504	001	1340	1540	3340	3540

3-Lead 5-Lead
Connector* 3-Lead 5-Lead Shielded Shielded

*See Reference Guide inside back cover.

504US	001	1340	1540	3340	3540
506	001	1340	1540	3340	3540
507	001	1340	1540	3340	3540
508	001	1340	1540	3340	3540
602-4 USP	001	1340	1540	3340	3540
602-A USP	001	1340	1540	3340	3540
Poet 2	001	1340	1540	3340	3540
Scholar	001	1340	1540	3340	3540

DATAMEDIX

Guardian 1001	001	1340	1540	3340	3540
MD3A	001	1340	1540	3340	3540
N1001	001	1340	1540	3340	3540

DATASCOPE

2000	001	1351	1551	3351	3551
2000 Respirator	001	1340	1540	3340	3540
2001	001	1351	1551	3351	3551
2001 Respirator	001	1340	1540	3340	3540
2002	001	1351	1551	3351	3551
2002 Respirator	001	1340	1540	3340	3540
2100	001	1351	1551	3351	3551
2100 Respirator	001	1340	1540	3340	3540
2200	001	1351	1551	3351	3551
2200 Respirator	001	1340	1540	3340	3540
3000	001	1351	1551	3351	3551
3000A	001	1351	1551	3351	3551
Ballon Pump	001	1351	1551	3351	3551
EL (Respirator)	001	1340	1540	3340	3540
Guardian	001	1340	1540	3340	3540
M/D3 w/ lead select	001	1351	1551	3351	3551
M/D3A	001	1351	1551	3351	3551
M/D4	001	1351	1551	3351	3551
Passport	001	1351	1551	3351	3551
Passport (Respirator)	001	1340	1540	3340	3540
Passport EL	001	1351	1551	3351	3551
Passport XG	001	1351	1551	3351	3551
Passport XL	001	1351	1551	3351	3551
System (SYS) 90	001	1351	1551	3351	3551
System (SYS) 90T	001	1351	1551	3351	3551
System (SYS) 97	001	1351	1551	3351	3551

E FOR M

Guardian	001	1340	1540	3340	3540
Guardian 1001	001	1340	1540	3340	3540
MD3A	001	1340	1540	3340	3540
N1001	001	1340	1540	3340	3540

ELECTRODYNE

Guardian	001	1340	1540	3340	3540
Guardian 1001	001	1340	1540	3340	3540
MD3A	001	1340	1540	3340	3540
N1001	001	1340	1540	3340	3540
ES-100	001	1351	1551	3351	3551

GE MEDICAL SYSTEMS

1200 Defib Series	001	1340	1540	3340	3540
1500 Defib Series	001	1340	1540	3340	3540
556	001	1340	1540	3340	3540
8720	001	1340	1540	3340	3540
900 Defib Series	001	1340	1540	3340	3540
9720	001	1340	1540	3340	3540
Cinamap 8700	001	1340	1540	3340	3540
Cinamap 8710	001	1340	1540	3340	3540



Medical Device Cross Reference - continued

3-Lead 5-Lead
Connector* 3-Lead 5-Lead Shielded Shielded

*See Reference Guide inside back cover.

Cinamap 8720	001	1340	1540	3340	3540
Cinamap 9700	001	1340	1540	3340	3540
Cinamap 9710	001	1340	1540	3340	3540
Cinamap 9720	001	1340	1540	3340	3540
Critikon 8100T	001	1340	1540	3340	3540
Corometrics 556	001	1340	1540	3340	3540
Dash 1000	004	1306	1506	3306	3506
Dash 2000	004	1306	1506	3306	3506
Dash 3000	004	1306	1506	3306	3506
Dash 4000	004	1306	1506	3306	3506
Dinamap	001	1340	1540	3340	3540
Dinamap Plus	001	1340	1540	3340	3540
Dynamap Pro	001	1340	1540	3340	3540
Eagle MAC Lab	004	1306	1506	3306	3506
Eagle Systems	004	1306	1506	3306	3506
MPS	001	1340	1540	3340	3540
R-Wave Detector (Starcam)	001	1340	1540	3340	3540
Solar 3000	004	1306	1506	3306	3506
Solar 8000	004	1306	1506	3306	3506
Solar 9500	004	1306	1506	3306	3506
Tram 100	004	1306	1506	3306	3506
Tram 200	004	1306	1506	3306	3506
Tram 300	004	1306	1506	3306	3506
Tram 400	004	1306	1506	3306	3506
Tram 500	004	1306	1506	3306	3506
Tram 600	004	1306	1506	3306	3506
Tram 800	004	1306	1506	3306	3506
Tramscope 12	004	1306	1506	3306	3506
Tramscope 12C	004	1306	1506	3306	3506
Unity Systems	004	1306	1506	3306	3506

GE TE MEDICAL

2 Channel Recorder	004	1306	1506	3306	3506
3 Channel Recorder	004	1306	1506	3306	3506

HEWLETT PACKARD

12 Pin Connector	002	1385	1585	3385	3585
43100A (12-Pin)	002	1385	1585	3385	3585
43110A (12-Pin)	002	1385	1585	3385	3585
43120A (12-Pin)	002	1385	1585	3385	3585
78352C	002	1385	1585	3385	3585
78354C	002	1385	1585	3385	3585
78834A (Neonatal Bedside)	002	1385	1585	3385	3585
78834C Neonatal	002	1385	1585	3385	3585
Agilent A1	001	1340	1540	3340	3540
Codemaster	002	1385	1585	3385	3585
Compact M3923A	001	1340		3340	
Compact M3925A	001	1340		3340	
Compact M3929A	001	1340		3340	
M1001A	002	1385	1585	3385	3585
M1002A	002	1385	1585	3385	3585
M1106A	002	1385	1585	3385	3585
M1175A	002	1385	1585	3385	3585
M1176A	002	1385	1585	3385	3585
M1280A	002	1385	1585	3385	3585
M1722A	002	1385	1585	3385	3585
M1722B	002	1385	1585	3385	3585
M1723A (12-Pin)	002	1385	1585	3385	3585
M1723B (12-Pin)	002	1385	1585	3385	3585
Merlin System	002	1385	1585	3385	3585
OmniCare (CMS)	002	1385	1585	3385	3585
V24	002	1385	1585	3385	3585

3-Lead 5-Lead
Connector* 3-Lead 5-Lead Shielded Shielded

*See Reference Guide inside back cover.

V26	002	1385	1585	3385	3585
Viridia 24	002	1385	1585	3385	3585
Viridia 24 C	002	1385	1585	3385	3585
Viridia 24 CT	002	1385	1585	3385	3585
Viridia M3	002	1385	1585	3385	3585
Viridia M4	002	1385	1585	3385	3585

HILL-ROM

Porta-Fib I	001	1340	1540	3340	3540
Porta-Fib II	001	1340	1540	3340	3540
Porta-Fib III	001	1340	1540	3340	3540
Porta-Fib III	001	1340	1540	3340	3540
System 5 (new)	001	1340	1540	3340	3540

HONEYWELL

Guardian	001	1340	1540	3340	3540
Guardian 1001	001	1340	1540	3340	3540
MD3A	001		1540		3540
N1001	001	1340	1540	3340	3540

ICR

208 (w/ lead select)	001	1340	1540	3340	3540
400 Series (5 lead)	001		1540		3540
4014	001	1340	1540	3340	3540
4045 Defib	001	1340	1540	3340	3540
408 (w/ lead select)	001	1340	1540	3340	3540
412 (w/ lead select)	001	1340	1540	3340	3540
413 (w/ lead select)	001	1340	1540	3340	3540
414 (w/ lead select)	001	1340	1540	3340	3540
500 Series	001	1340	1540	3340	3540
511	001	1340	1540	3340	3540
512	001	1340	1540	3340	3540
514	001	1340	1540	3340	3540
521	001	1340	1540	3340	3540
522	001	1340	1540	3340	3540
524	001	1340	1540	3340	3540
526	001	1340	1540	3340	3540
600 Series	001	1340	1540	3340	3540
701S	001	1340		3340	
702S	001	1340		3340	
703S	001	1340		3340	
900 Series - With Resistor	001		1540		3540
900 Series - Without Resistor	001		1551		3551
900 Series (w/ respiration)	001	1351	1551	3351	3551
900 Series (w/o respiration)	001	1340	1540	3340	3540
90300	001		1540		3540
90303B	001		1540		3540
90305	001		1540		3540
90308	001	1340	1540	3340	3540
90308-11	001	1340	1540	3340	3540
90367 Ultraview	003	1396	1596	3396	3596
90369	003	1396	1596	3396	3596
90408	001		1540		3540
90418	001		1540		3540
90425	001		1540		3540
90428	001		1540		3540
90431	001	1340	1540	3340	3540
90432	001		1540		3540
90470	001		1540		3540
90496	003	1396	1596	3396	3596
90600 Series	001	1340	1540	3340	3540
90600A Series	001	1340	1540	3340	3540

(ICR continued on next page)



Medical Device Cross Reference – continued

3-Lead 5-Lead
Connector* 3-Lead 5-Lead Shielded Shielded

*See Reference Guide inside back cover.

(ICR continued from previous page)

90700	001	1340	...	1540	3340	3540
90700 Series	001	1340	3340	
90701	001	1340	...	1540	3340	3540
90721	001	1340	...	1540	3340	3540
90724	001	1340	...	1540	3340	3540
Medic 3	001	1340	...	1540	3340	3540
Medic 4	001	1340	...	1540	3340	3540
Medic 4 (Defib)	001	1340	...	1540	3340	3540
Medic 5	001	1340	...	1540	3340	3540
PC Bedside	001	1340	3340	
PC Bed Side Series	001	1340	3340	
PC Express	001	1340	3340	
PCMS System	001	1340	...	1540	3340	3540
PCMS System 90300 Series	001	1340	3340	
TEK-208	001	1340	3340	
TEK-408	001	1340	3340	
TEK-412	001	1340	3340	
TEK-413	001	1340	3340	
TEK-413 with Lead Select	001	1340	...	1540	3340	3540
TEK-413/414 (w/ lead select)	001	1340	...	1540	3340	3540
TEK-414	001	1340	3340	
TEK-414 with Lead Select	001	1340	...	1540	3340	3540
TEK-511	001	1340	...	1540	3340	3540
TEK-512	001	1340	...	1540	3340	3540
TEK-514	001	1340	...	1540	3340	3540
TEK-521	001	1340	...	1540	3340	3540

INTERSPEC IREX

880	001	1351	...	1551	3351	3551
-----	-------	-----	-------	------	-----	------	-------	------	-------	------

INVIVO

400673	001	1340	...	1540	3340	3540
20100	001	1340	...	1540	3340	3540
20300	001	1340	...	1540	3340	3540
Escort 100	001	1340	...	1540	3340	3540
Escort 101	001	1340	...	1540	3340	3540
Escort 102	001	1340	...	1540	3340	3540
Escort 200	001	1340	...	1540	3340	3540
Escort 300	001	1340	...	1540	3340	3540
Escort Prism	001	1340	...	1540	3340	3540
Escort Prism SE	001	1340	...	1540	3340	3540
Prism	001	1340	...	1540	3340	3540

INVIVO RESEARCH

3200	001	1340	...	1540	3340	3540
3202	001	1340	...	1540	3340	3540
3200/3202 NVS/TVS	001	1340	...	1540	3340	3540
M12	001	1340	...	1540	3340	3540
M6	001	1340	...	1540	3340	3540
Magnitude	001	1340	...	1540	3340	3540
Magnitude CV	001	1340	...	1540	3340	3540
Millenia	001	1351	...	1551	3351	3551
NVS	001	1340	...	1540	3340	3540
Omni Trak	001	1351	...	1551	3351	3551
Omni Trak 300	001	1340	...	1540	3340	3540
Omni Trak 3000	001	1340	...	1540	3340	3540
Omni Trak 3001	001	1340	...	1540	3340	3540
Omni Trak 3100	001	1340	...	1540	3340	3540
Omni Trak 3150	001	1340	...	1540	3340	3540
TVS	001	1340	...	1540	3340	3540

IREX

880	001	1351	...	1551	3351	3551
-----	-------	-----	-------	------	-----	------	-------	------	-------	------

3-Lead 5-Lead
Connector* 3-Lead 5-Lead Shielded Shielded

*See Reference Guide inside back cover.

IVY BIOMEDICAL SYSTEMS

101	001	1351	...	1551	3351	3551
101 (After 1988)	001	1351	...	1551	3351	3551
101 (Bef 1989)	001	1351	...	1551	3351	3551
101 (Before 1989)	001	1340	...	1540	3340	3540
101 T	001	1340	...	1540	3340	3540
101B	001	1351	...	1551	3351	3551
101T	001	1351	...	1551	3351	3551
201	001	1351	...	1551	3351	3551
202	001	1351	...	1551	3351	3551
301	001	1351	...	1551	3351	3551
302	001	1351	...	1551	3351	3551
303	001	1351	...	1551	3351	3551
303A	001	1340	...	1540	3340	3540
303D	001	1340	...	1540	3340	3540
401	001	1351	...	1551	3351	3551
402	001	1340	...	1540	3340	3540
403	001	1340	...	1540	3340	3540
403D	001	1340	...	1540	3340	3540
404	001	1351	...	1551	3351	3551
405	001	1351	...	1551	3351	3551
405A	001	1340	...	1540	3340	3540
405D	001	1340	...	1540	3340	3540
405P	001	1340	...	1540	3340	3540
405R	001	1340	...	1540	3340	3540
405T	001	1340	...	1540	3340	3540
450	001	1340	...	1540	3340	3540
700	001	1340	...	1540	3340	3540
701	001	1340	...	1540	3340	3540
702	001	1340	...	1540	3340	3540
702A	001	1351	...	1551	3351	3551
703	001	1351	...	1551	3351	3551
703T	001	1340	...	1540	3340	3540
704	001	1351	...	1551	3351	3551
705	001	1340	...	1540	3340	3540
706	001	1340	...	1540	3340	3540
R-Guard 101 NR	001	1340	...	1540	3340	3540
R-Guard 101 R	001	1340	...	1540	3340	3540
Vital Guard 450CM	001	1340	...	1540	3340	3540
Vital Guard 450CN	001	1340	...	1540	3340	3540

J&J

880	001	1351	...	1551	3351	3551
-----	-------	-----	-------	------	-----	------	-------	------	-------	------

LASER SYSTEM & ELECTRIC

Vista 1	001	1351	...	1551	3351	3551
---------	-------	-----	-------	------	-----	------	-------	------	-------	------

LIFE SCIENCE INSTRUMENTS

LS261	001	1340	...	1540	3340	3540
LS5	001	1340	...	1540	3340	3540

LITTON

Guardian	001	1340	...	1540	3340	3540
Guardian 1001	001	1340	...	1540	3340	3540
MD3A	001	1540	3540
N1001	001	1340	...	1540	3340	3540

LSE

Vista 1	001	1351	...	1551	3351	3551
LS261	001	1340	...	1540	3340	3540
LS5	001	1340	...	1540	3340	3540

MALLINCKRODT

791018	001	1340	...	1540	3340	3540
4000	001	1340	...	1540	3340	3540



Medical Device Cross Reference - continued

	Connector*	3-Lead	5-Lead	Shielded	Shielded
*See Reference Guide inside back cover.					
N-1000	001	1340	1540	3340	3540
N200	001	1340	1540	3340	3540
N-200	001	1340	1540	3340	3540
N250	001	1340	1540	3340	3540
N-250	001	1340	1540	3340	3540
NPB-3900	001	1340	1540	3340	3540
OEC 6120A	001	1340	1540	3340	3540

MARQUETTE ELECTRONICS

1200 Defib Series	001	1340	1540	3340	3540
1500 Defib Series	001	1340	1540	3340	3540
556	001	1340	1540	3340	3540
8720	001	1340	1540	3340	3540
900 Defib Series	001	1340	1540	3340	3540
Cinamap 8700	001	1340	1540	3340	3540
Cinamap 8710	001	1340	1540	3340	3540
Cinamap 8720	001	1340	1540	3340	3540
Cinamap 9700	001	1340	1540	3340	3540
Cinamap 9710	001	1340	1540	3340	3540
Corometrics 556	001	1340	1540	3340	3540
Dash 1000	004	1306	1506	3306	3506
Dash 2000	004	1306	1506	3306	3506
Dash 3000	004	1306	1506	3306	3506
Dash 4000	004	1306	1506	3306	3506
Eagle MAC Lab	004	1306	1506	3306	3506
Eagle Systems	004	1306	1506	3306	3506
R-Wave Detector (Starcam)	001	1340	1540	3340	3540
Solar 3000	004	1306	1506	3306	3506
Solar 8000	004	1306	1506	3306	3506
Solar 9500	004	1306	1506	3306	3506
Tram 100	004	1306	1506	3306	3506
Tram 200	004	1306	1506	3306	3506
Tram 300	004	1306	1506	3306	3506
Tram 400	004	1306	1506	3306	3506
Tram 500	004	1306	1506	3306	3506
Tram 600	004	1306	1506	3306	3506
Tram 800	004	1306	1506	3306	3506
Tramscope 12	004	1306	1506	3306	3506
Tramscope 12C	004	1306	1506	3306	3506
Unity Systems	004	1306	1506	3306	3506

MATRX MEDICAL

Life Defense Plus (LDP)Defib	001	1340	1540	3340	3540
------------------------------	-----	------	------	------	------

MDE

400673	001	1340	1540	3340	3540
20100	001	1340	1540	3340	3540
20300	001	1340	1540	3340	3540
Escort 100	001	1340	1540	3340	3540
Escort 101	001	1340	1540	3340	3540
Escort 102	001	1340	1540	3340	3540
Escort 200	001	1340	1540	3340	3540
Escort 300	001	1340	1540	3340	3540
Escort Prism	001	1340	1540	3340	3540
Escort Prism SE	001	1340	1540	3340	3540
Prism	001	1340	1540	3340	3540

MEDICAL DATA ELECTRONICS

400673	001	1340	1540	3340	3540
20100	001	1340	1540	3340	3540
20300	001	1340	1540	3340	3540
Escort 100	001	1340	1540	3340	3540
Escort 101	001	1340	1540	3340	3540

	Connector*	3-Lead	5-Lead	Shielded	Shielded
*See Reference Guide inside back cover.					
Escort 102	001	1340	1540	3340	3540
Escort 200	001	1340	1540	3340	3540
Escort 300	001	1340	1540	3340	3540
Escort Prism	001	1340	1540	3340	3540
Escort Prism SE	001	1340	1540	3340	3540
Prism	001	1340	1540	3340	3540

MEDICAL RESEARCH LABS

360SL	001	1340	1540	3340	3540
450 Preamp	001	1340	1540	3340	3540
450SL	001	1340	1540	3340	3540
500PBS	001	1340	1540	3340	3540
521A	001	1340	1540	3340	3540
EMS-5	001	1340	1540	3340	3540
EMS-6	001	1340	1540	3340	3540
MD521	001	1340	1540	3340	3540
MDR5200	001	1340	1540	3340	3540
MDR521	001	1340	1540	3340	3540
MDR529	001	1340	1540	3340	3540
Portapak 1000 Isolated	001	1340	1540	3340	3540
Portapak 80	001	1340	1540	3340	3540
Portapak 90	001	1340	1540	3340	3540
Pre-Amp (Isolated)	001	1340	1540	3340	3540
Pre-Amp-450	001	1340	1540	3340	3540

MEDTEL

114-500	001	1351	1551	3351	3551
351-126	001	1351	1551	3351	3551
351-696	001	1340	1540	3340	3540
HS20	001	1351	1551	3351	3551
HS30	001	1351	1551	3351	3551
HS40	001	1351	1551	3351	3551

MEDTRONIC PHYSIO-CONTROL

1440	001	1551	3551		
911ST	001	1551	3551		
Life Pak 5 with lead select	001	1351	1551	3351	3551
Lifepak 10 Straight Connector	001	1551	3551		
Lifepak 5 Straight Connector	001	1551	3551		
Lifepak 6	001	1351	1551	3351	3551
Lifepak 6S	001	1551	3551		
Lifepak 7 Straight Connector	001	1551	3551		
Lifepak 8 Straight Connector	001	1551	3551		
Lifepak 9 Straight Connector	001	1551	3551		
Lifepak 9A	001	1551	3551		
Lifepak 9P	001	1551	3551		
Physio 1440/R	001	1351	1551	3351	3551
VSM-1	001	1340	1540	3340	3540
VSM-1ESF (w/ resistors)	001	1340	1540	3340	3540
VSM-1ESF (w/o resistors)	001	1351	1551	3351	3551
VSM-2	001	1351	1551	3351	3551
VSM-2ESF	001	1351	1551	3351	3551
VSM-3	001	1340	1540	3340	3540
VSM-3 (w/o resistors)	001	1351	1551	3351	3551
VSM-4	001	1340	1540	3340	3540
VSM-5	001	1340	1540	3340	3540

MOTOROLA

Apcor Radio	001	1340	1540	3340	3540
-------------	-----	------	------	------	------

MRL

360SL	001	1340	1540	3340	3540
450 Preamp	001	1340	1540	3340	3540

(MRL continued on next page)



Medical Device Cross Reference – continued

Connector* 3-Lead 5-Lead
3-Lead 5-Lead
Shielded Shielded

*See Reference Guide inside back cover.

(MRL continued from previous page)

450SL	001	1340	1540	3340	3540
500PBS	001	1340	1540	3340	3540
521A	001	1340	1540	3340	3540
EMS-5	001	1340	1540	3340	3540
EMS-6	001	1340	1540	3340	3540
MD521	001	1340	1540	3340	3540
MDR5200	001	1340	1540	3340	3540
MDR521	001	1340	1540	3340	3540
MDR529	001	1340	1540	3340	3540
Portapak 1000 Isolated	001	1340	1540	3340	3540
PortaPak 80	001	1340	1540	3340	3540
PortaPak 90	001	1340	1540	3340	3540
Pre-Amp (Isolated)	001	1340	1540	3340	3540
Pre-Amp-450	001	1340	1540	3340	3540

NARCO

HRRM 71-1/2	001	1340	1540	3340	3540
HRRM-71	001	1340	1540	3340	3540
HRRM-72	001	1340	1540	3340	3540
Porta-Fib I	001	1340	1540	3340	3540
Porta-Fib II	001	1340	1540	3340	3540
Porta-Fib III	001	1340	1540	3340	3540
System 5 (new)	001	1340	1540	3340	3540
System 6 (Neonatal)	001	1340	1540	3340	3540

NELLCOR INC

791018	001	1340	1540	3340	3540
4000	001	1340	1540	3340	3540
N-1000	001	1340	1540	3340	3540
N200	001	1340	1540	3340	3540
N-200	001	1340	1540	3340	3540
N250	001	1340	1540	3340	3540
N-250	001	1340	1540	3340	3540
NPB-3900	001	1340	1540	3340	3540
OEC 6120A	001	1340	1540	3340	3540

NIHON KOHDEN

BSM-8301	001	1340	1540	3340	3540
BSM-8301A	001	1340	1540	3340	3540
BSM-8302	001	1340	1540	3340	3540
BSM850 SERIES	001	1340	1540	3340	3540
BSM-8500A	001	1340	1540	3340	3540
BSM-8502	001	1340	1540	3340	3540
Cardiolife 5000	001	1340	1540	3340	3540
Cardiolife 7000	001	1340	1540	3340	3540
Life Scope 9	001	1351	1551	3351	3551
OEC-6102A (s/n>20156)	001	1340	1540	3340	3540
OEC-6105A (s/n<20226)	001	1340	1540	3340	3540
OEC-6105A (s/n>20226)	001	1340	1540	3340	3540
OEC-6120A	001	1340	1540	3340	3540
OEC-6120A	001	1340	1540	3340	3540
OEC-6120J	001	1340	1540	3340	3540
OEC-6120K	001	1340	1540	3340	3540
OEC-7102A	001	1340	1540	3340	3540
OEC-8108A	001	1340	1540	3340	3540
OEC-8120A	001	1340	1540	3340	3540
TEC-5200A (s/n>20421)	001	1340	1540	3340	3540
TEC-7100A	001	1340	1540	3340	3540
TEC-7200A	001	1340	1540	3340	3540
TEC-7300A	001	1340	1540	3340	3540

Connector* 3-Lead 5-Lead
3-Lead 5-Lead
Shielded Shielded

*See Reference Guide inside back cover.

NORTH AMERICAN DRAEGER

Cable with out Resistors	001	1351	1551	3351	3551
Cable with Resistors	001	1340	1540	3340	3540
Vitalert 1000	001	1340	1540	3340	3540
Vitalert 2000	001	1340	1540	3340	3540

NOVAMETRIX MEDICAL SYSTEMS

902	001	1351	1551	3351	3551
903	001	1351	1551	3351	3551
910	001	1351	1551	3351	3551
Life Defense 1	001	1340	1540	3340	3540
Neonatal	001	1340	1540	3340	3540
Pace-Tech MiniMax 4000CL	001	1351		3351	
Minipack 300	001	1351		3351	
Minipack 3000	001	1351		3351	
Minipack 3100	001	1351		3351	
Vitalmax 800 Plus	001	1351		3351	
Vitalmax 2000	001	1351		3351	
Vitalmax 2100	001	1351		3351	
Vitalmax 2200	001	1351		3351	
Vitalmax 4000	001	1351		3351	
Vitalmax 4000 Modular CL	001	1351		3351	
Vitalmax 4000CL	001	1351		3351	
Vitalmax 4100	001	1351		3351	
Vitalmax 4100 CL	001	1351		3351	

PHILIPS MEDICAL SYSTEMS

12 Pin Connector	002	1385	1585	3385	3585
43100A (12-Pin)	002	1385	1585	3385	3585
43110A (12-Pin)	002	1385	1585	3385	3585
43120A (12-Pin)	002	1385	1585	3385	3585
78352C (12-Pin)	002	1385	1585	3385	3585
78354C (12-Pin)	002	1385	1585	3385	3585
78834A Neonatal Bedside (12-Pin)	002	1385	1585	3385	3585
78834C Neonatal (12-Pin)	002	1385	1585	3385	3585
Agilent A1	002	1385		3385	
Codemaster	002	1385	1585	3385	3585
Compact M3923A	001	1340		3340	
Compact M3925A	001	1340		3340	
Compact M3929A	001	1340		3340	
M1001A (12-Pin)	002	1385	1585	3385	3585
M1002A (12-Pin)	002	1385	1585	3385	3585
M1106A (12-Pin)	002	1385	1585	3385	3585
M1175A (12-Pin)	002	1385	1585	3385	3585
M1176A (12-Pin)	002	1385	1585	3385	3585
M1280A (12-Pin)	002	1385	1585	3385	3585
M1722A (12-Pin)	002	1385	1585	3385	3585
M1722B (12-Pin)	002	1385	1585	3385	3585
M1723A (12-Pin)	002	1385	1585	3385	3585
M1723B (12-Pin)	002	1385	1585	3385	3585
Merlin System (12-Pin)	002	1385	1585	3385	3585
OmniCare (CMS) (12-Pin)	002	1385	1585	3385	3585
V24 (12-Pin)	002	1385	1585	3385	3585
V26 (12-Pin)	002	1385	1585	3385	3585
Viridia 24 (12-Pin)	002	1385	1585	3385	3585
Viridia 24 C (12-Pin)	002	1385	1585	3385	3585
Viridia 24 CT (12-Pin)	002	1385	1585	3385	3585
Viridia M3 (12-Pin)	002	1385	1585	3385	3585
Viridia M4 (12-Pin)	002	1385	1585	3385	3585



Medical Device Cross Reference - continued

Connector* 3-Lead 5-Lead Shielded Shielded

*See Reference Guide inside back cover.

PHYSIO-CONTROL

1440	001	1551	3551
911ST	001	1551	3551
Life Pak 5 with lead select ..	001	1351 .. 1551	3351 .. 3551
Lifepak 10 Straight Connector	001	1551	3551
Lifepak 5 Straight Connector	001	1551	3551
Lifepak 6	001	1351 .. 1551	3351 .. 3551
Lifepak 6S	001	1551	3551
Lifepak 7 Straight Connector	001	1551	3551
Lifepak 8 Straight Connector	001	1551	3551
Lifepak 9 Straight Connector	001	1551	3551
Lifepak 9A	001	1551	3551
Lifepak 9P	001	1551	3551
Physio 1440/R	001	1351 .. 1551	3351 .. 3551
VSM-1	001	1340 .. 1540	3340 .. 3540
VSM-1ESF (w/ resistors)	001	1340 .. 1540	3340 .. 3540
VSM-1ESF (w/o resistors) ..	001	1351 .. 1551	3351 .. 3551
VSM-2	001	1351 .. 1551	3351 .. 3551
VSM-2ESF	001	1351 .. 1551	3351 .. 3551
VSM-3	001	1340 .. 1540	3340 .. 3540
VSM-3 (w/o resistors)	001	1351 .. 1551	3351 .. 3551
VSM-4	001	1340 .. 1540	3340 .. 3540
VSM-5	001	1340 .. 1540	3340 .. 3540

PIONEER

1125	001	1340	3340
1700	001	1340	3340
26125	001	1340	3340
33167	001	1340	3340
33167	001	1340	3340
5260	001	1340	3340
5260	001	1340	3340
5330	001	1340	3340
5330	001	1340	3340
Pulsar 4	001	1340	3340

PPG

Guardian	001	1340 .. 1540	3340 .. 3540
Guardian 1001	001	1340 .. 1540	3340 .. 3540
MD3A	001	1540	3540
N1001	001	1340 .. 1540	3340 .. 3540

PROTOCOL SYSTEMS

Atlas	001	1340 .. 1540	3340 .. 3540
Propack 102	001	1340 .. 1540	3340 .. 3540
Propack 103	001	1340 .. 1540	3340 .. 3540
Propack 104	001	1340 .. 1540	3340 .. 3540
Propack 106	001	1340 .. 1540	3340 .. 3540
Propaq 100 Series (Disc.)	001	1340 .. 1540	3340 .. 3540
Propaq 200 Series	001	1340 .. 1540	3340 .. 3540
Propaq Atlas			
(3,5 Ld w/ Lead Select)	001	1340 .. 1540	3340 .. 3540
Propaq CS			
(3,5 Ld w/ Lead Select)	001	1340 .. 1540	3340 .. 3540
Propaq Encore	001	1340 .. 1540	3340 .. 3540
Propaq Encore			
(3,5 Ld w/ Lead Select)	001	1340 .. 1540	3340 .. 3540
Propaq Encore 202	001	1340 .. 1540	3340 .. 3540
Propaq Encore 204	001	1340 .. 1540	3340 .. 3540
Propaq Encore 206	001	1340 .. 1540	3340 .. 3540
Ultra Smart	001	1340 .. 1540	3340 .. 3540
Ultra Smart with 90 Degrees	001	1340 .. 1540	3340 .. 3540
Vital Signs	001	1340 .. 1540	3340 .. 3540

Connector* 3-Lead 5-Lead Shielded Shielded

*See Reference Guide inside back cover.

PURITAN BENNETT

791018	001	1340 .. 1540	3340 .. 3540
4000	001	1340 .. 1540	3340 .. 3540
N-1000	001	1340 .. 1540	3340 .. 3540
N200	001	1340 .. 1540	3340 .. 3540
N-200	001	1340 .. 1540	3340 .. 3540
N250	001	1340 .. 1540	3340 .. 3540
N-250	001	1340 .. 1540	3340 .. 3540
NPB-3900	001	1340 .. 1540	3340 .. 3540
OEC 6120A	001	1340 .. 1540	3340 .. 3540

QUINTON INSTRUMENTS

Q-Cath	001	1340 .. 1540	3340 .. 3540
Q-Cath	001	1340 .. 1540	3340 .. 3540

SIEMENS ELECTROMEDICAL SYSTEMS

350 Series	001	1340	3340
400-500 ECG Respirator	001	1351 .. 1551	3351 .. 3551
Sirecust 630	001	1340	3340
Sirecust DU	001	1340	3340

SPACELABS MEDICAL

208 (w/ lead select)	001	1340 .. 1540	3340 .. 3540
400 Series (5 lead)	001	1540	3540
4014	001	1340 .. 1540	3340 .. 3540
4045 Defib	001	1340 .. 1540	3340 .. 3540
408 (w/ lead select)	001	1340 .. 1540	3340 .. 3540
412 (w/ lead select)	001	1340 .. 1540	3340 .. 3540
413 (w/ lead select)	001	1340 .. 1540	3340 .. 3540
414 (w/ lead select)	001	1340 .. 1540	3340 .. 3540
500 Series	001	1340 .. 1540	3340 .. 3540
511	001	1340 .. 1540	3340 .. 3540
512	001	1340 .. 1540	3340 .. 3540
514	001	1340 .. 1540	3340 .. 3540
521	001	1340 .. 1540	3340 .. 3540
522	001	1340 .. 1540	3340 .. 3540
524	001	1340 .. 1540	3340 .. 3540
526	001	1340 .. 1540	3340 .. 3540
600 Series	001	1340 .. 1540	3340 .. 3540
701S	001	1340	3340
702S	001	1340	3340
703S	001	1340	3340
900 Series - With Resistor ..	001	1540	3540
900 Series - Without Resistor	001	1551	3551
900 Series (w/ respiration) ..	001	1351 .. 1551	3351 .. 3551
900 Series (w/o respiration)	001	1340 .. 1540	3340 .. 3540
90300	001	1540	3540
90303B	001	1540	3540
90305	001	1540	3540
90308	001	1340 .. 1540	3340 .. 3540
90308-11	001	1340 .. 1540	3340 .. 3540
90367 Ultraview	003	1396 .. 1596	3396 .. 3596
90369	003	1396 .. 1596	3396 .. 3596
90408	001	1540	3540
90418	001	1540	3540
90425	001	1540	3540
90428	001	1540	3540
90431	001	1340 .. 1540	3340 .. 3540
90432	001	1540	3540
90470	001	1540	3540
90496	003	1396 .. 1596	3396 .. 3596
90600 Series	001	1340 .. 1540	3340 .. 3540

(SPACELABS continued on next page)



Medical Device Cross Reference – continued

Connector* 3-Lead 5-Lead
3-Lead 5-Lead
Shielded Shielded

*See Reference Guide inside back cover.

(SPACELABS continued from previous page)

90600A Series	001	1340	1540	3340	3540
90700	001	1340	1540	3340	3540
90700 Series	001	1340		3340	
90701	001	1340	1540	3340	3540
90721	001	1340	1540	3340	3540
90724	001	1340	1540	3340	3540
Medic 3	001	1340	1540	3340	3540
Medic 4	001	1340	1540	3340	3540
Medic 4 (Defib)	001	1340	1540	3340	3540
Medic 5	001	1340	1540	3340	3540
PC Bedside	001	1340		3340	
PC Bed Side Series	001	1340		3340	
PC Express	001	1340		3340	
PCMS System	001	1340	1540	3340	3540
PCMS System 90300 Series	001	1340		3340	
TEK-208	001	1340		3340	
TEK-408	001	1340		3340	
TEK-412	001	1340		3340	
TEK-413	001	1340		3340	
TEK-413 with Lead Select	001	1340	1540	3340	3540
TEK-413/414 (w/ lead select)	001	1340	1540	3340	3540
TEK-414	001	1340		3340	
TEK-414 with Lead Select	001	1340	1540	3340	3540
TEK-511	001	1340	1540	3340	3540
TEK-512	001	1340	1540	3340	3540
TEK-514	001	1340	1540	3340	3540
TEK-521	001	1340	1540	3340	3540

TEKTRONIX

208 (w/ lead select)	001	1340	1540	3340	3540
400 Series (5 lead)	001		1540		3540
4014	001	1340	1540	3340	3540
4045 Defib	001	1340	1540	3340	3540
408 (w/ lead select)	001	1340	1540	3340	3540
412 (w/ lead select)	001	1340	1540	3340	3540
413 (w/ lead select)	001	1340	1540	3340	3540
414 (w/ lead select)	001	1340	1540	3340	3540
500 Series	001	1340	1540	3340	3540
511	001	1340	1540	3340	3540
512	001	1340	1540	3340	3540
514	001	1340	1540	3340	3540
521	001	1340	1540	3340	3540
522	001	1340	1540	3340	3540
524	001	1340	1540	3340	3540
526	001	1340	1540	3340	3540
600 Series	001	1340	1540	3340	3540
701S	001	1340		3340	
702S	001	1340		3340	
703S	001	1340		3340	
900 Series - With Resistor	001		1540		3540
900 Series - Without Resistor	001		1551		3551
900 Series (w/ respiration)	001	1351	1551	3351	3551
900 Series (w/o respiration)	001	1340	1540	3340	3540
90300	001		1540		3540
90303B	001		1540		3540
90305	001		1540		3540
90308	001	1340	1540	3340	3540
90308-11	001	1340	1540	3340	3540
90367 Ultraview	003	1396	1596	3396	3596
90369	003	1396	1596	3396	3596
90408	001		1540		3540

Connector* 3-Lead 5-Lead
3-Lead 5-Lead
Shielded Shielded

*See Reference Guide inside back cover.

90418	001	1540		3540	
90425	001	1540		3540	
90428	001	1540		3540	
90431	001	1340	1540	3340	3540
90432	001	1540		3540	
90470	001	1540		3540	
90496	003	1396	1596	3396	3596
90600 Series	001	1340	1540	3340	3540
90600A Series	001	1340	1540	3340	3540
90700	001	1340	1540	3340	3540
90700 Series	001	1340		3340	
90701	001	1340	1540	3340	3540
90721	001	1340	1540	3340	3540
90724	001	1340	1540	3340	3540
Medic 3	001	1340	1540	3340	3540
Medic 4	001	1340	1540	3340	3540
Medic 4 (Defib)	001	1340	1540	3340	3540
Medic 5	001	1340	1540	3340	3540
PC Bedside	001	1340		3340	
PC Bed Side Series	001	1340		3340	
PC Express	001	1340		3340	
PCMS System	001	1340	1540	3340	3540
PCMS System 90300 Series	001	1340		3340	
TEK-208	001	1340		3340	
TEK-408	001	1340		3340	
TEK-412	001	1340		3340	
TEK-413	001	1340		3340	
TEK-413 with Lead Select	001	1340	1540	3340	3540
TEK-413/414 (w/ lead select)	001	1340	1540	3340	3540
TEK-414	001	1340		3340	
TEK-414 with Lead Select	001	1340	1540	3340	3540
TEK-511	001	1340	1540	3340	3540
TEK-512	001	1340	1540	3340	3540
TEK-514	001	1340	1540	3340	3540
TEK-521	001	1340	1540	3340	3540

TEMTECH

Lifeguard 9	001	1351	1551	3351	3551
M401	001	1351	1551	3351	3551
M501	001	1351	1551	3351	3551
M503	001	1351	1551	3351	3551

VIASYS

400673	001	1340	1540	3340	3540
20100	001	1340	1540	3340	3540
20300	001	1340	1540	3340	3540
Escort 100	001	1340	1540	3340	3540
Escort 101	001	1340	1540	3340	3540
Escort 102	001	1340	1540	3340	3540
Escort 200	001	1340	1540	3340	3540
Escort 300	001	1340	1540	3340	3540
Escort Prism	001	1340	1540	3340	3540
Escort Prism SE	001	1340	1540	3340	3540
Prism	001	1340	1540	3340	3540

VICKERS

HRRM 71-1/2	001	1340	1540	3340	3540
HRRM-71	001	1340	1540	3340	3540
HRRM-72	001	1340	1540	3340	3540
Porta-Fib I	001	1340	1540	3340	3540
Porta-Fib II	001	1340	1540	3340	3540
Porta-Fib III	001	1340	1540	3340	3540
Porta-Fib III	001	1340	1540	3340	3540



Medical Device Cross Reference - continued

3-Lead 5-Lead
Connector* 3-Lead 5-Lead Shielded Shielded

*See Reference Guide inside back cover.

System 5 (new)	001	1340	...	1540	3340	3540
System 6 (Neonatal)	001	1340	...	1540	3340	3540
VIATEK									
208 (w/ lead select)	001	1340	...	1540	3340	3540
400 Series (5 lead)	001	1540	3540
4014	001	1340	...	1540	3340	3540
4045 Defib	001	1340	...	1540	3340	3540
408 (w/ lead select)	001	1340	...	1540	3340	3540
412 (w/ lead select)	001	1340	...	1540	3340	3540
413 (w/ lead select)	001	1340	...	1540	3340	3540
414 (w/ lead select)	001	1340	...	1540	3340	3540
511	001	1340	...	1540	3340	3540
512	001	1340	...	1540	3340	3540
514	001	1340	...	1540	3340	3540
521	001	1340	...	1540	3340	3540
522	001	1340	...	1540	3340	3540
524	001	1340	...	1540	3340	3540
526	001	1340	...	1540	3340	3540
500 Series	001	1340	...	1540	3340	3540
600 Series	001	1340	...	1540	3340	3540
701S	001	1340	3340	
702S	001	1340	3340	
703S	001	1340	3340	
900 Series - With Resistor ..	001	1540	3540
900 Series - Without Resistor	001	1551	3551
900 Series (w/ respiration) ..	001	1351	...	1551	3351	3551
900 Series (w/o respiration)	001	1340	...	1540	3340	3540
90300	001	1540	3540
90303B	001	1540	3540
90305	001	1540	3540
90308	001	1340	...	1540	3340	3540
90308-11	001	1340	...	1540	3340	3540
90367 Ultraview	003	1396	...	1596	3396	3596
90369	003	1396	...	1596	3396	3596
90408	001	1540	3540
90418	001	1540	3540
90425	001	1540	3540
90428	001	1540	3540
90431	001	1340	...	1540	3340	3540
90432	001	1540	3540
90470	001	1540	3540
90496	003	1396	...	1596	3396	3596
90600 Series	001	1340	...	1540	3340	3540
90600A Series	001	1340	...	1540	3340	3540
90700	001	1340	...	1540	3340	3540
90700 Series	001	1340	3340	
90701	001	1340	...	1540	3340	3540
90721	001	1340	...	1540	3340	3540
90724	001	1340	...	1540	3340	3540
Medic 3	001	1340	...	1540	3340	3540
Medic 4	001	1340	...	1540	3340	3540
Medic 4 (Defib)	001	1340	...	1540	3340	3540
Medic 5	001	1340	...	1540	3340	3540
PC Bedside	001	1340	3340	
PC Bed Side Series	001	1340	3340	
PC Express	001	1340	3340	
PCMS System	001	1340	...	1540	3340	3540
PCMS System 90300 Series	001	1340	3340	
TEK-208	001	1340	3340	
TEK-408	001	1340	3340	

3-Lead 5-Lead
Connector* 3-Lead 5-Lead Shielded Shielded

*See Reference Guide inside back cover.

TEK-412	001	1340	3340	
TEK-413	001	1340	3340	
TEK-413 with Lead Select ..	001	1340	...	1540	3340	3540
TEK-413/414 (w/ lead select)	001	1340	...	1540	3340	3540
TEK-414	001	1340	3340	
TEK-414 with Lead Select ..	001	1340	...	1540	3340	3540
TEK-511	001	1340	...	1540	3340	3540
TEK-512	001	1340	...	1540	3340	3540
TEK-514	001	1340	...	1540	3340	3540
TEK-521	001	1340	...	1540	3340	3540

WELCH ALLYN PROTOCOL

Atlas	001	1340	...	1540	3340	3540
Propack 102	001	1340	...	1540	3340	3540
Propack 103	001	1340	...	1540	3340	3540
Propack 104	001	1340	...	1540	3340	3540
Propack 106	001	1340	...	1540	3340	3540
Propaq 100 Series (Disc.) ...	001	1340	...	1540	3340	3540
Propaq 200 Series	001	1340	...	1540	3340	3540
Propaq Atlas (3,5 Ld w/ Lead Select)	001	1340	...	1540	3340	3540
Propaq CS (3,5 Ld w/ Lead Select)	001	1340	...	1540	3340	3540
Propaq Encore	001	1340	...	1540	3340	3540
Propaq Encore (3,5 Ld w/ Lead Select)	001	1340	...	1540	3340	3540
Propaq Encore 202	001	1340	...	1540	3340	3540
Propaq Encore 204	001	1340	...	1540	3340	3540
Propaq Encore 206	001	1340	...	1540	3340	3540
Ultra Smart	001	1340	...	1540	3340	3540
Ultra Smart with 90 Degrees	001	1340	...	1540	3340	3540
Vital Signs	001	1340	...	1540	3340	3540

ZMI

8000-00-25	001	1340	...	1540	3340	3540
D-90	001	1340	...	1540	3340	3540
D900	001	1340	...	1540	3340	3540
PD1200	001	1340	...	1540	3340	3540
PD1400	001	1340	...	1540	3340	3540
PD-2000	001	1340	...	1540	3340	3540

ZOLL MANUFACTURING (ZMI)

8000-00-25	001	1340	...	1540	3340	3540
D-90	001	1340	...	1540	3340	3540
D900	001	1340	...	1540	3340	3540
PD1200	001	1340	...	1540	3340	3540
PD1400	001	1340	...	1540	3340	3540
PD-2000	001	1340	...	1540	3340	3540

This cross-reference guide is based upon the best data available at the time of compilation from many different sources. Devices may change without notice. Please match your device connector to the illustrations found on page G-1, the next page of this document.



REFERENCE GUIDE

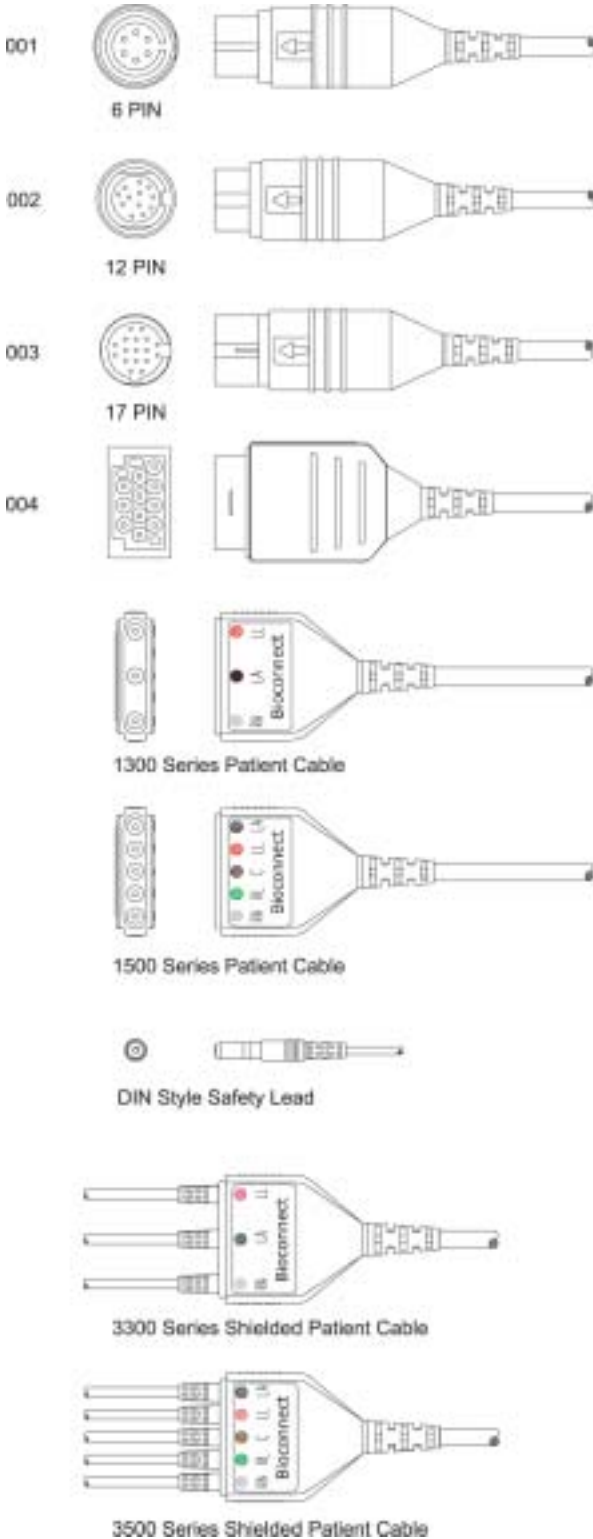

These illustrations are provided to confirm that our connector is a match for your device.
Carefully count the exact number of pins or sockets.





Made in the USA

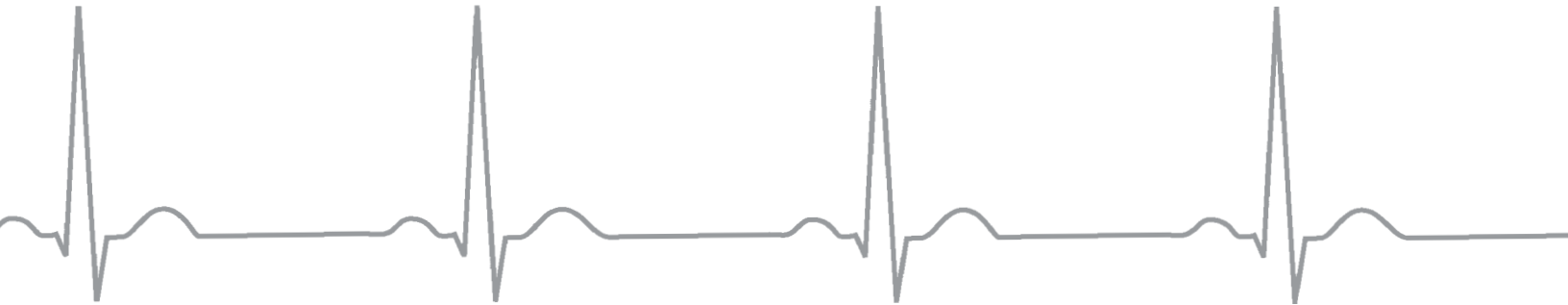

CONTACT US:

CNA Medical

2000 Murifield Ave.
Rockwall, TX 75087, U.S.A.
Tel: 972-771-9434
Fax: 972-771-3100
cnamedical@cnamedical.com
www.cnamedical.com

